

2025

OP15 USER MANUAL



925.215.7315 | WWW.OPUSCAMPER.US
BUILT BY OPUS CAMPER IN CALIFORNIA

OPUS

WELCOME TO THE OPUS FAMILY!

Congratulations on your new OP15! We worked hard to blend everything you love about each model into the ultimate camping machine... and we got the OP15. We truly hope this trailer makes your outdoor adventures more enjoyable and exciting.

While your dealership should be able to answer any questions you have, we are happy to assist with any further questions. We are committed to providing the highest level of customer service and this User Manual was created specifically to guide you through your new OP15. We strongly recommend familiarizing yourself with it before operating your trailer. Understanding your trailer, and following the instructions and warnings in this manual, will eliminate avoidable problems and ensure you get the most out of your camper. The OP15 is built to last and with considerate treatment and care it will be your adventure companion for years to come. You can download a digital copy of this manual on our website: <https://www.opuscamper.us/user-manuals/>

Download Digital
OP15 User Manual:

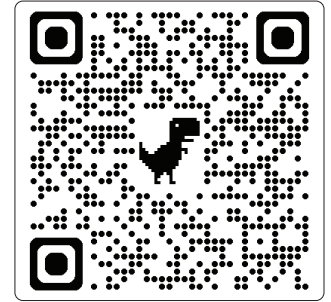

We demand a high standard of build quality and our team follows a rigorous build and inspection process before delivery. Your dealership will also run an independent inspection on the camper before it reaches you. If you suspect your OPUS Camper is not working correctly, please contact your dealer to arrange an appointment. If you experience a problem while traveling, please contact your dealership before an independent local service carries out repairs - it's important to ensure you will still be covered under warranty. Retain all invoices and documentation to allow for proper reimbursement through your dealer.

The OP15 trailer is designed for recreational use only. Please read the warranty in this document to ensure you're adhering to the intended trailer usage covered under the warranty. Usage outside of these terms could reduce or void your warranty. The full warranty is outlined in this manual and available on our website.

Please note there may be differences in the products or designs shown or described in this manual from your camper. Because we promote ongoing improvements to our trailers and builds, we reserve the right to change the construction or design at any time without the obligation to make these changes on previously manufactured trailers. If significant changes are made to the design or build of our models, we will take the appropriate steps to update this manual accordingly.

Should you have any questions about your OP15 trailer, no matter how small we are here to help. You can reach us at info@opuscamper.us or call us at 925.215.7215.

Welcome to the family!!

OPUS CAMPER USA

Submit your Opus Adventure!

Share trip details to be published on the Opus Camper Adventure Map.

www.opuscamper.us/opus-adventure-addicts-2/



1. Specifications
2. Specifications
3. Control Panel
4. Battery Tips
5. Hitch - DO35 Cruisemaster
6. Towing - Brakes, Chains, Wheels
7. Trailer Set-Up Guide
8. Trailer Set-Up Guide
9. Trailer Set-Up Guide
10. Trailer Set-Up Guide
11. Awning - Fiamma F45S
12. Exterior Kitchen Set-Up
13. 12V Fridge - ICECO VL75 ProD
14. 12V Fridge - cont..
15. About Your Slideout Kitcher
16. Dometic Penguin II 120v A/C
17. Inverter - Victron MultiPlus 2000VA
18. Electrical System
19. Electrical System
20. Electrical System
21. Electrical System
22. Electrical System
23. Pack-Down Guide
24. Pack-Down Guide
25. Pack-Down Guide
26. Pack-Down Guide
27. Gas System - Propane
28. Gas System - Propane
29. Truma Combi Eco & Water Heating
30. Truma Winterization & Warnings
31. Water System
32. Water System
- 32a Water System - Exterior Shower
- 32b Water System - Water Line Diagrams
33. Water System - Grey & Black Tanks
34. Water System - Grey & Black Tanks
35. Bathroom - Toilet, Shower, Sink
36. Television
37. Windows
38. Front Door
39. Trailer Maintenance - Brakes & Fire Safety
40. Trailer Maintenance - Greasing & Servicing
41. Winterization - Batteries
42. Winterization - Water Systems
43. Winterization - Water Systems
44. Changing a Tire
45. Tool Inside OP15
46. Warranty
47. Warranty cont.
48. Warranty cont.
49. Warranty cont.
50. Appliance Resources

BE AN OPUS ADVENTURE ADDICT



Submit your Opus Adventure on our website to be featured on the Opus Adventure Map!

www.opuscamper.us

OP15 SPECIFICATIONS

BUILD

Color	Matte Black with Orange Stripe
Dry Weight	5,070 lbs
Tongue Weight	460 lbs
GVWR	6000 lbs
Ground Clearance	13.5 inches
Body Work	Baked Enamel Finish
Material	Di-bond aluminum composite panel exterior with aluminum sub-structure
Chassis	Fully galvanized & welded chassis
Drawbar	Fully galvanized & welded drawbar
Stone Guard	Anti-chip protected
Stabilizers	Drop Down Adjustable Heavy Duty Stabilizer legs
Tongue Jack Wheel	ARK 750 Dual Tongue Jack
Steps	Manual
Wheels	265/75R/16 Mud Tires (including 2 x spares) and Alloy Wheels
Brake System	12v Electric Drum Brakes w/ E-brake to assist w/ brake-away system.



MEASUREMENTS & SPECIFICATIONS

EXTERIOR SPECIFICATIONS:

Ride Height	106 in <i>(roof down)</i>
Ride Width	84 in
Ride Length	173 in <i>(roof down and rear closed)</i>
Set-up Length	220 in <i>(rear closed)</i>
Set-up Height	123 in <i>(roof up)</i>

INTERIOR SPECIFICATIONS:

Interior Height	82 in <i>(roof up)</i>
Interior Height	64 in <i>(roof down)</i>
Canvas Height:	18 in <i>(extended)</i>
Interior Length	209 in <i>(rear extended)</i>
Interior Length	162 in <i>(rear closed)</i>
Interior Width:	80 in

FEATURES

Coupling	Cruisemaster DO35
Suspension	Independent Trailing Arm Coil Spring Suspension with Dual Shock Absorbers *UPGRADED RE-ENGINEERED SUSPENSION with vertical spring positioning
Exterior Kitchen	Exterior Slide out Stainless Steel Kitchen with 4 burner gas stove & sink with electric tap,
Refrigerator	12V FRIDGE - ICECO VL75 ProD Portable Refrigerator
Pop-Top Roof	Aluminum frame with top aluminum sheet and Fiberglass interior wall

Batteries	3 x 135ah Lithium Batteries = 405ah
Solar	6 x 100 watt solar panels with Renergy 30 amp solar charge controller
TV	12v capable TV with exterior mounting bracket and Antenna
Lights	Interior & Exterior 12v powered LED Lights
Shore Power	30 amp shore power connection & cable
Stereo	JBL Bluetooth Speaker

WATER

Potable Water Capacity	63 gallons (spread across 2 tanks)
Grey Water Capacity	17 gallons
Black Water Capacity	10 gallons
Water tank guard	Checker plate
Water system	1 x 12v electric pump
Hot Water	Truma Combi Heater and Hot Water System (12V Propane System) - Provides hot water to the outdoor kitchen sink & shower, and the indoor bathroom. kitchen & sink.

INTERIOR FEATURES

Seating/Dining	Leatherette Seating with adjustable pivot position table
Furniture	Premium Bamboo Interior Cabinetry and wardrobe
Bathroom	Ensuite with premium shower, sink, chemical toilet, storage, a mirror and retractable faucet
Heating	Truma Combi Heater and Hot Water System (runs off propane & 12v)
A/C	Domestic Panguin II - 120v A/C
Bed Size	Mattress Size (Main Bed) = 85 in x 66 in Mattress Folded (travel mode) = 41 in x 66 in
Bunk Sizes:	Top Bunk: 80" x 30" Lower Bunk: 80" x 45"

VIN #

Your OP15 has a Vehicle Identification Number (VIN). The VIN Plate can be found near the tongue of your trailer and placed directly on the chassis. Save your VIN in the template as shown. This will be required by insurance companies.

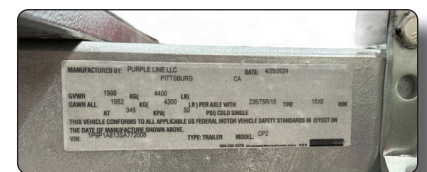

MANUFACTURED BY:			DATE:		
GVWR	KG	LB			
GVWR ALL	KG	LB	PER AXLE WITH	TIRE	RIM
AT	KG	PSI	COLD SINGLE		
THIS VEHICLE CONFORMS TO ALL APPLICABLE US FEDERAL MOTOR VEHICLE SAFETY STANDARDS IN EFFECT ON THE DATE OF MANUFACTURE SHOWN ABOVE.					
VIN:		TYPE: TRAILER	MODEL:		

CONTROL PANEL

FUNCTIONS:

1. Power ON/OFF Button: Powers on your trailers (lights, roof lift, etc)
2. Battery Level Indicator: Shows the current charge level of the batteries. Knowing the battery level is crucial for operating trailer features like lights, pumps, and stabilizers, especially when not connected to shore power. The Battery Monitor also shows the electrical voltage of your trailers batteries, acting as a gauge to indicate how much power is currently available. Also pay attention to your amps if you are running a 120v appliance via the inverter; try plugging each appliance in separately to check its amperage draw to help you better understand and manage your power supply.
3. Front Water Tank Level Gauge: Monitors water levels in your front tank. If you prefer to pull water from a specific tank, use the blue valve to select a tank - more information on page 31.
4. Rear Water Tank Level Gauge: Monitors water levels in your rear tank. If you prefer to pull water from a specific tank, use the blue valve to select a tank - more information on page 31.
5. Black Water Tank Level Gauge: Monitors how full your Black Tank is.
6. Grey Water Tank Level Gauge: Monitors how full your Grey Tank is.
7. Fridge Outlet Power Button: Must be ON to power your fridge.
8. 12 Volt Socket Power Button: Must be ON to use any of the 12V outlets inside and outside your trailer.
9. Lights Power Button: Must be ON to use interior and exterior lights.
10. Water Pump Power Button: Must be on ON to pump water from all locations on your OP15 - Including the exterior shower, sink, and bathroom.

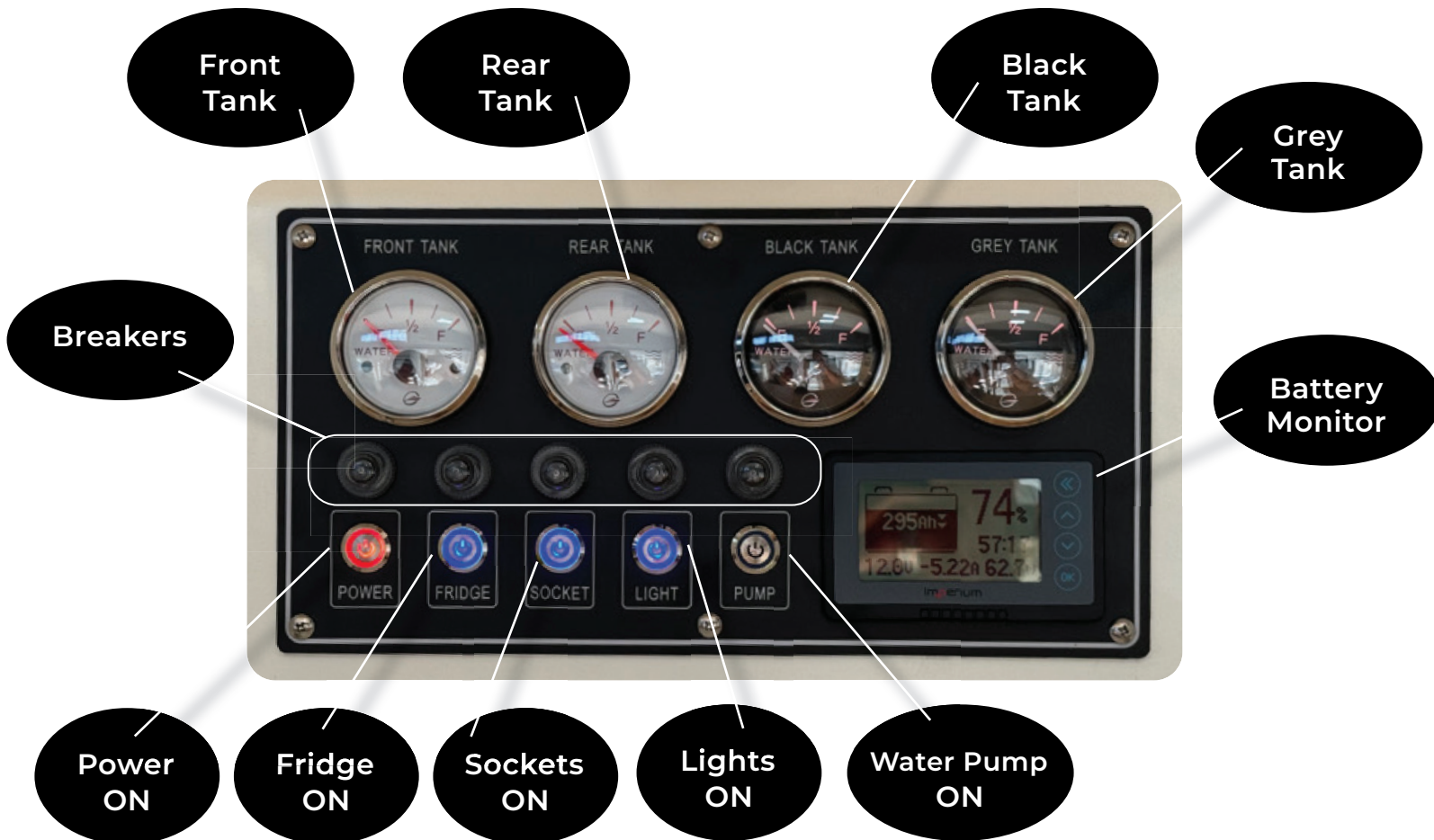

VICTRON 2000 WATT INVERTER

- The OP15 comes with the Victron MultiPlus 2000VA Inverter. This is a combined inverter and charger in one package. Its many features include a true sine wave inverter, adaptive charging, hybrid PowerAssist technology, plus multiple system integration features.
- Download Manual here: <https://www.opuscamper.us/download/21547/?tmstv=1721074259>

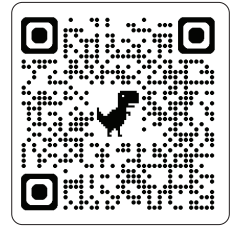

BATTERIES: The OP15 comes standard with 3 x 135ah Lithium Batteries = 405ah of power.

MONITOR YOUR AMP METER:

- Please pay close attention to your amp meter if you are running a 120v appliance via the inverter; try plugging each appliance in separately to check its amperage draw to help you better understand and manage your power supply.
- On the control panel you will find the main 12v ON/OFF switch. There are separate switches for the following 12 volt operated appliances and systems in the OP15: Fridge, Sockets, Lights, Water Pump.

CHARGING YOUR TRAILER WITH SHORE POWER

- To charge your battery using shore power, you must flip the “Main” switch on inside the battery compartment.
- The exterior shore power hookup is located on the driver’s side at the front of the OP15. Your OP15 comes supplied with a 30 Amp shore power cable and pigtail connection for both campsite and home outlet connection. Ensure proper maintenance of the power cord and pigtail accessory items.
- Always use a Listed and approved 30 Amp cable and adapter and a grounded power source. Never use an extension cord.
- DANGER! Due to the potential danger to ignore this warning, the recreational vehicle manufacturer cannot be held responsible should damage, injury or death result from failure to connect the power cord to a properly grounded power source.



USING YOUR INVERTER

INVERTER SWITCH LOCATION

Your OP15 has a 12v to 120v changeover switch and inverter installed located in the battery compartment.

TURNING ON YOUR INVERTER

To turn on your inverter, make sure the power button on the side of the inverter is turned on..

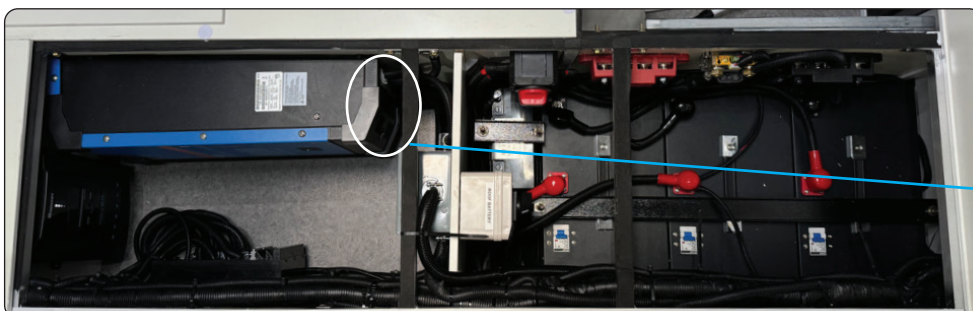

HITCHING UP

ABOUT YOUR HITCH DO35 CRUISEMASTER

Tow Vehicle Side Hitch

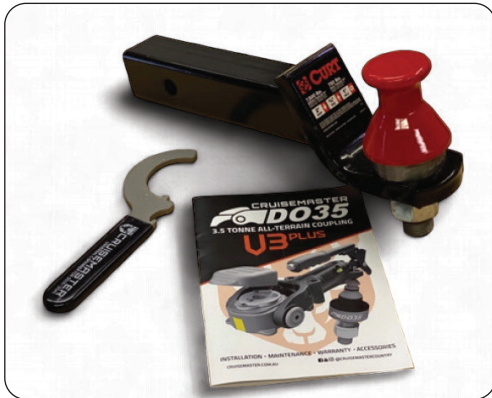

Trailer Side Hitch



Saracen DO35 Hitch Lock



For coupling the DO35 to your vehicle, we recommend the following:

- Ensure Tow Pin Cover is removed from Tow Pin.
- Make sure Tow Pin and Universal mating surfaces free of sand, dirt and foreign objects, and is lightly lubricated.
- Raise height of trailer coupling above vehicle Tow Pin by adjusting Jockey Wheel or Stand.
- Push and hold Lock Button down (push the Lock Plate to full open position until the Lock Button is able to spring back)

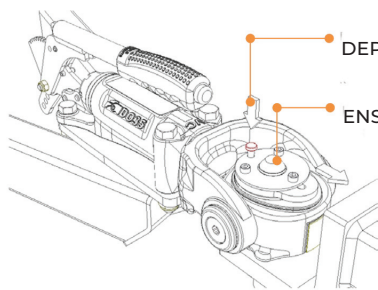
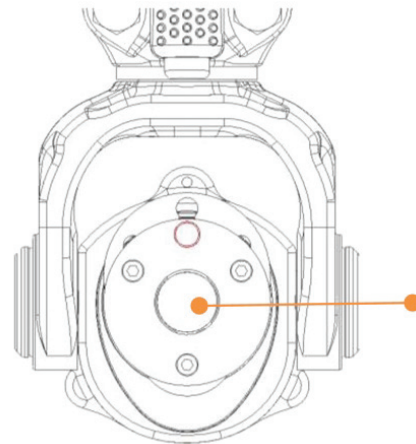

DEPRESS RED BUTTON FOR SPRING LOADED SLIDE TO LOCK COUPLING TO VEHICLE

ENSURE TOW PIN PROTRUDES THROUGH LOCKING MECHANISM BEFORE ATTEMPTING TO LOCK

- Align Coupling over Tow Pin by moving either vehicle or trailer, and lower coupling onto Tow Pin. Ensure that Universal is fully seated on Tow Pin; Ensure Tow Pin protrudes through locking plate.
- Push the Lock Button to release the plate into the locked position.

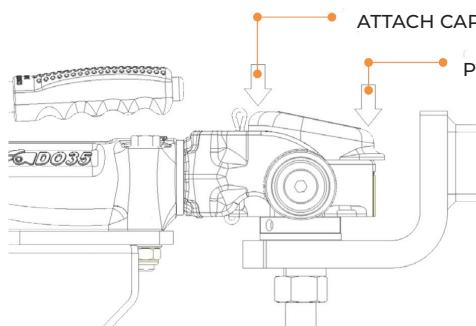

ATTACH CAP FROM THE REAR FIRST FOR EASIER FITMENT

PRESS FRONT OF CAP FIRM AND ENSURE SNAP FIT.

- Assemble the Checklock cap by snapping in the back edge of the cap first and then pushing down on the front. The cap will emit an audible snap when assembled correctly.

ON YOUR TRAILER TONGUE:



7 PIN ELECTRICAL PLUG

7 PIN The OPUS® is fitted with a 7-pin flat plug that connects all the exterior trailer running/brake/turn lights and the electric brakes to the towing vehicle. You will require a 7-pin connection on your tow-vehicle as well as an in-car electric brake controller installed in your tow vehicle to operate them.

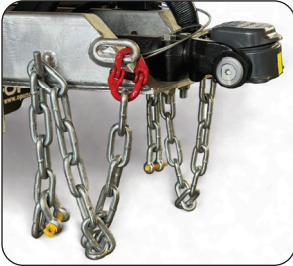

INSTALLING YOUR SAFETY CHAINS

The OPUS® is fitted with 2 safety chains on the tongue. One end of the chain is fitted to the OPUS® chassis and the other end has an attachment clip which should be attached securely to your tow vehicle bumper or receiver. Ensure that you have enough slack in the chains to turn your vehicle adequately. Should you require less slack, the chains can be twisted or crossed below the tongue before connecting to your vehicle to ensure the chains do not drag on the ground. Do not attach the hooks to the hitch itself.

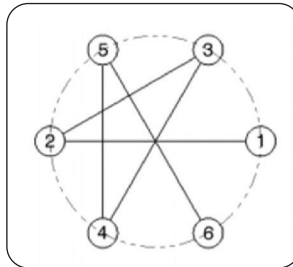

WHEELS

Torque all wheel bolts to 100ft lbs. When tightening wheel nut lugs, please tighten bolts in a star-pattern order as indicated in the diagram to the right.



ABOUT YOUR BRAKES

The OPUS® is fitted with electric trailer brakes. You need an electric brake controller fitted to your car in order to tow the OPUS® and operate the electric breaks safely. Failure to tow with a brake controller in your vehicle is both dangerous and illegal. You can tell if your brakes are working properly by connecting the 7-pin plug, starting the engine of the tow vehicle and then getting someone to listen to the brake hub whilst another person applies the brakes in the tow vehicle. If they are working correctly you will here a low humming sound as the brakes are applied.

BRAKE MAINTENANCE

As part of the annual service check you should have completed by an accredited industry service agent, the brakes will be checked and maintained.

TOWING

The driver of the tow vehicle must ensure that their Driving License is valid for towing the OPUS® Camper. It is essential that you adhere to any applicable laws for the state in which you are driving. Many guides are available from leading associations and should be studied before you embark. Trailer towing laws are different in each state. Please be aware If you are traveling across multiple states that you could suddenly be breaking tow laws if you're not careful. States differ on their rules about multiple trailers. If you're hauling a camper and a Jet Ski behind it, you'd be OK in South Carolina, but breaking the law once you cross the Georgia state line.

No matter where you are in the U.S., the following features are safety equipment for trailer towing:

- * Lights: Your trailer lights must be maintained in working order for basic road safety.
- * License plate light: Make sure to clearly display your license plate
- * Reflectors:
- * Flares: Keep these at hand to clear off a section of the road after an accident.
- * Tie-downs: If you are loading anything on a trailer that could possibly fall off, you'll need tie-downs to secure it at multiple angles.

OP15 SET-UP GUIDE

This section covers trailer set-up only. Please see detailed instructions for your kitchen, heater, gas, electric and water systems in this manual.



Watch Related Videos:

While there are key differences in setting up each model, these videos are excellent resources for details about hitching up, setting up your kitchen, and your electrical system. Video link: <https://www.youtube.com/watch?v=joBPqaXiQB0>

STEP 1: Unhitch & Level

- Once you have positioned your OPUS® in the desired location, engage the handbrake.
- Raise or lower the tongue jack wheel to level your OPUS® length ways.
- Use the level on the tongue of the trailer to determine if you're level.
- Remove all items from the Cargo Rack.

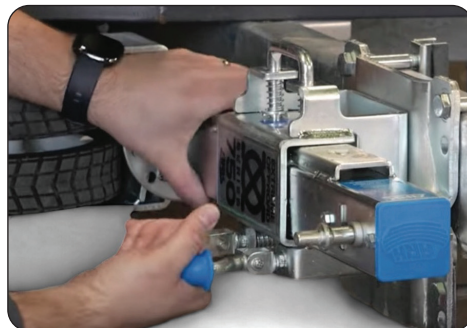

STEP 2: Release Securing Latches

- Disconnect the four roof securing latches;
- Use your thumb to push in the release pin
- Lift the handle to release the latch from the hook completely



STEP 3: Lower the Tires

- Remove the pin from the right side of the tire carrier holder.
- Pull the large securing pin out of the trailer arm..
- Remove the D pin from the latch with the red handle.
- Release the latch with the red handle to unlock the tire.
- Fold down one spare at a time using the gas struts to assist you.
- Repeat this proces with the other tire.

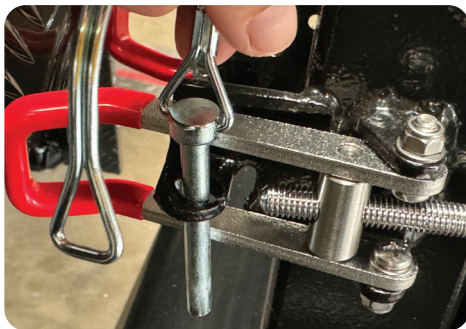
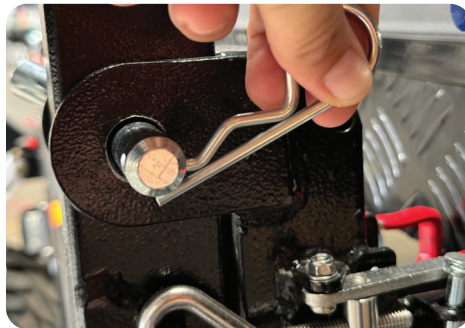
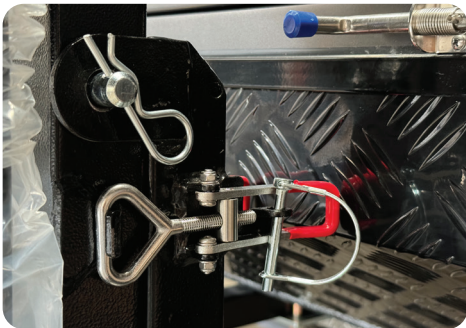

STEP 4: Swing Jerry Cans to Side

- Remove the securing pin and unlatch both sides of the Jerry Cans.
- Pull the securing spring to release the cages from the travel position.
- Hock the Jerry Can to through the latch to secure it during set-up.

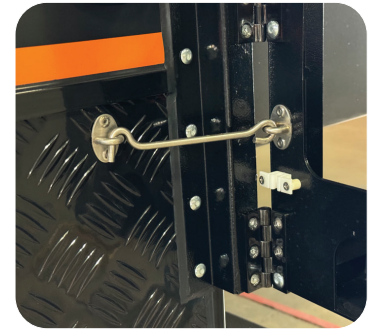
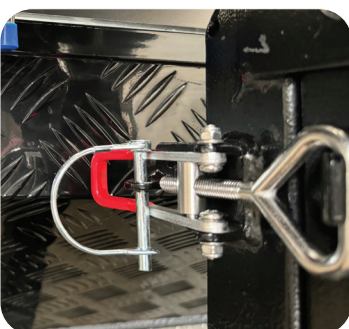

OP15 SET-UP GUIDE

STEP 5: Extend the Rear

- Use the push-buttons to open the rear panel securing locks. Lift the back panel upwards to the roof position.
- Using one hand or a helper to hold the roof panel up, pull and rotate the spring bolt that secures the side panel until it is in the vertical position. This will allow the side panels to swing outwards.
- Open the left side panel fully through 90 degrees, ensuring the panel meets the corner groove of the roof panel to complete the set-up and achieve a full seal. Repeat with the right side panel.
- Holding the bed panel securely, release the two rear bed panel securing latches and fold down the bed panel.

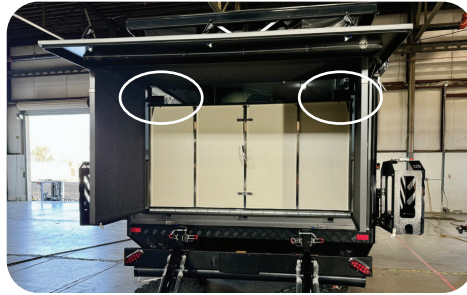
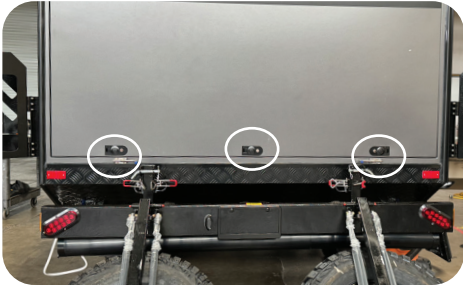

- Carefully lower the rear bed panel into the horizontal position.
- Use the handle to lift the rear end wall panel in place.
- Slide the two locking pins in place and then secure with the latch clamps.

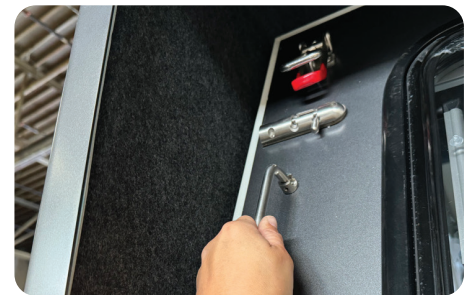

STEP 6: Extend the Roof

- Turn on the Power on the Control Panel located inside your OP15.
- Ensure all four of the Exterior Latches are properly released.
- Locate the switch labelled “Roof” on the left side of your entry door.
- Press the top of the button and hold until the roof is fully extended.



DEAD BATTERY - ROOF BACK-UP POWER

- Your OP15 comes with a dedicated battery to close or open your automated roof.
- The switch and battery are located in the main battery compartment.

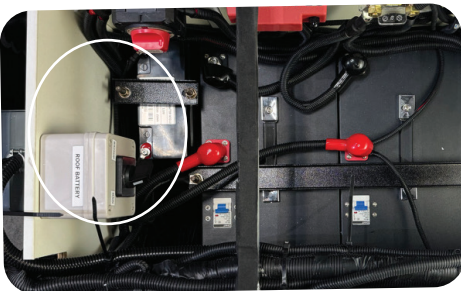

STEP 7: Stabilizer Legs

- Fold down the stabilizer leg using two hands; one to pull out the blue handle and the other to support the weight of the leg into the vertical position. This helps prevent damage to the locking pins.
- Use the included corner steady winder or 3/4" hex socket cordless drill/driver attachment, wind down each corner steady leg until it touches the ground.
- Depending on the terrain, you may need to adjust each corner to level the OPUS® to achieve a good level.

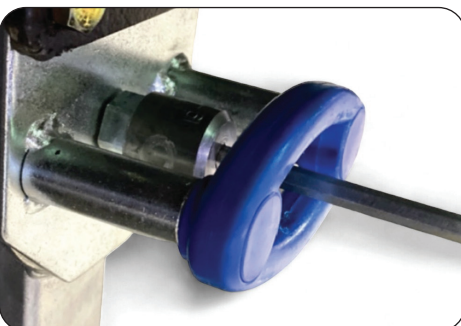

AWNING - FIAMMA F45S

AWNING - FIAMMA F45S - RETRACTABLE AWNING

The OP15 comes with a Fiamma retractable awning to provide coverage while cooking.

- When looking after your Fiamma awning, you should wash it with warm soapy water and let it dry completely before putting it away.
- The awning may only be used in very light wind and rain conditions. When periods of moderate rain and or wind are expected the awning must be closed. Please ensure the awning is retracted at the first sign of wind or rain conditions to prevent serious injury and damage. Damage caused by wind and rain is not covered under warranty. Never leave the awning open and unattended.
- Ensure your awning is fully retracted before moving your OP15 for any reason. Damage caused by failure to comply with this instruction is not covered under warranty. Damaged caused by collisions with objects in the area in which the awning will be deployed will not be covered under warranty. Do NOT overextend the awning. Ensure there is a good bend in the extension arm at all times.

SETTING-UP YOUR AWNING:

1. Lock the legs: Use the turn knobs to lock the legs into place for support
2. Wind out the awning: Continue to wind out the awning with the T-fitting crank provided with you OP15, at the same time continue to move the legs out.



3. Anchor the awning: If you're parked on grass, use a peg to anchor the awning through the foot. If you can't peg to the ground, use the mounting clips to attach the awning to the wall of your camper.
4. Tension the awning: Use a screwdriver to push the notch forward slightly to tension the roof and vinyl

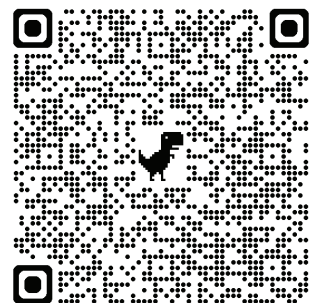

DOWNLOAD THE FIAMMA F45S USER MANUAL NOW:

OP15 EXTERIOR KITCHEN SET-UP GUIDE

STEP 8: Set-up your Kitchen

- Open the two push-button latches and fold down the kitchen door. Unhook the two locking spring-bolts and slide your kitchen out. Quick-connect your water and gas at the kitchen connection points and the quick connects on the side of the OP15. Please see the sections on Gas System, Water system and the Kitchen for more information on setting up the kitchen.
- Route your sink drainage hose out of the bottom of the kitchen and into your designated grey water carrier.
- Open and latch your OP15 storage cubby directly across from the entrance. Turn on the power located in the control panel on the right entry and switch on lights.

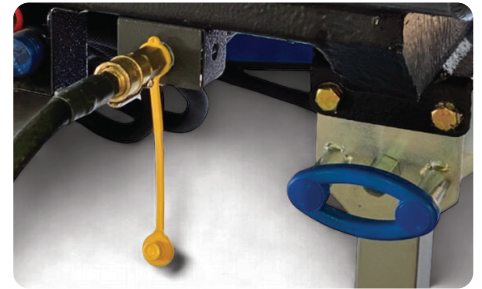

STEP 9: Stove Support Leg

- Release the latches and slide the kitchen out - You will feel it lock into place once pulled far enough.
- Release the kitchen support leg from under the kitchen. You can lock it into place with the screws provided.
- Once you release the support leg button, the leg will release quickly - Ensure everyone is away from the stove when releasing the leg.



12V FRIDGE - ICECO VL75 ProD Portable Refrigerator



The OP15 comes with the Iceco VL75 Pro 12v Fridge/Freezer. We recommend reading the manufacturer's user manual that comes with your fridge in full to understand how this appliance works and to assist in troubleshooting should this be required.

Operating your Fridge:

- Battery Protection Settings
- Power ON/OFF Button
- Compressor Speed (Eco/Max Mode)
- Right Zone Temp DOWN Button
- Right Zone Temp UP Button
- Left Zone Temp UP Button
- Left Zone Temp DOWN Button

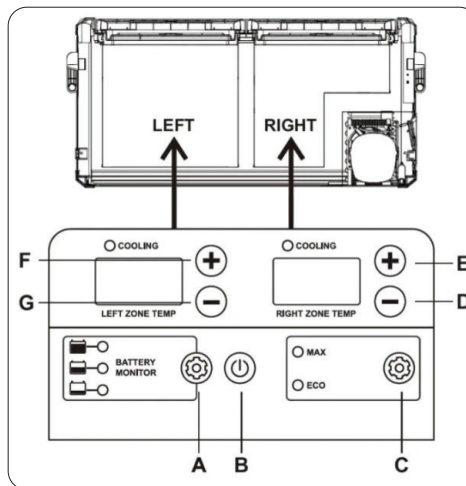

TIP: Two display screens correspond to the left and right zone respectively.

MAX & ECO Mode:

- With the unit turned on (Press & Hold B/Power Button).
- You can press the MODE Button C to toggle between MAX or ECO mode for the fridge.

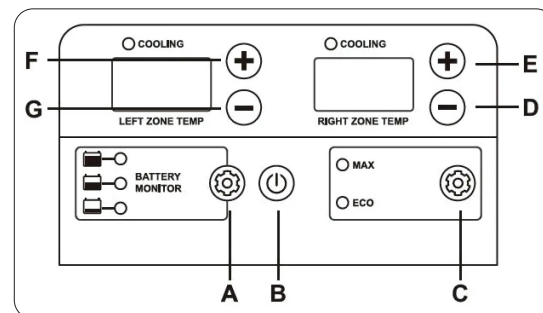

Switch Between °C and °F

- With the unit turned on'
- Press & Hold B /Power Button)
- Press and hold Button C and Button D for 3 seconds to toggle between the temperature values of Celsius & Fahrenheit.

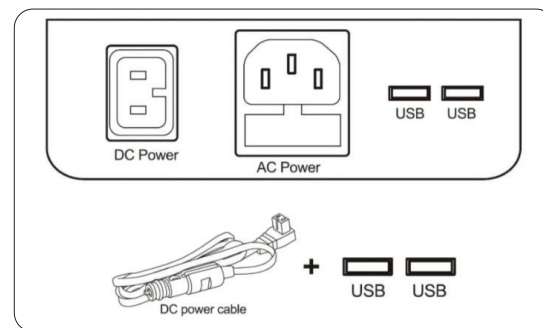

Single Zone Mode

- With the unit turned on:
- Press and hold Temperature UP Button F and Temperature DOWN Button G to turn on/off Left zone.
- Press and hold Temperature UP Button E and Temperature DOWN Button D to turn on/off Right zone.

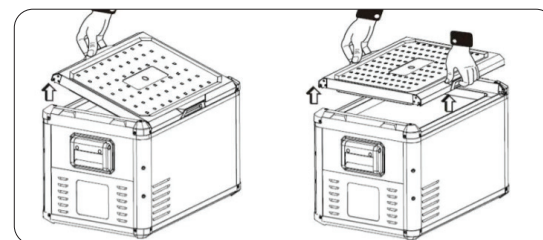

WARNINGS

See IMPORTANT warnings about your vridge on page 40 in the care and maintenance sections of this manual.

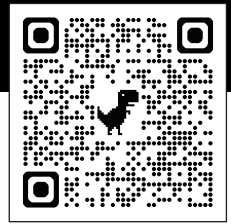

Setting the Temperature:

- With the unit turned on, the fridge's CURRENT interior temperature reading will appear on the display, as a solid= non-flashing number.

To change the fridge's set temperature:

- Press Temperature Up(Button E/F) to increase the temperature of the right/left zone.
- Press Temperature Down(Button D/G) to decrease the temperature of the right/left zone.
- The SET temperature will appear as a FLASHING number and after the temperature is SET, the display will return to show the fridge's CURRENT interior temperature.

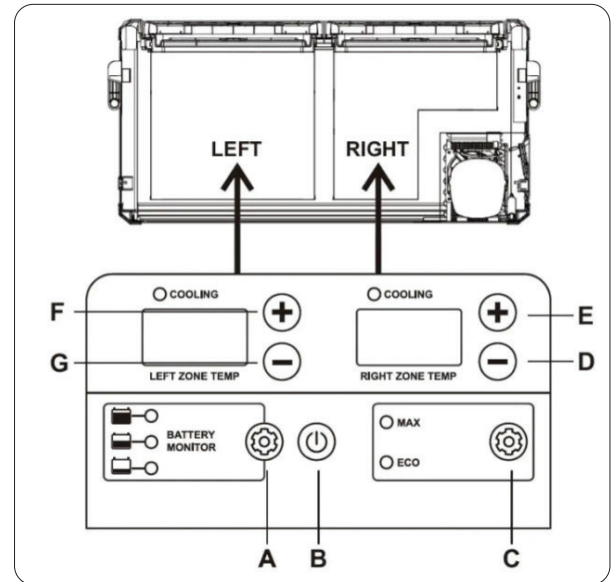

Opus Specific Operating Instructions:

- Your Fridge can be run on either 120v or 12v however we have designed the OP15 so that only 12v is supplied to the fridge compartment to enable the most energy efficient usage.
- The Fridge appliance is energy efficient and works well with minimum amperage draw. Please ensure that your fridge is set to 'low' or eco-mode to ensure you get the most efficient use and least impact on your 12v power consumption
- We recommend turning your fridge on and allowing it to come down to temperature 24 hrs before your trip and while connected to shore power as this is the time when your fridge will need to use the most energy.
- You can leave the fridge on while traveling; simply ensure the fridge switch on the main control panel is turned on.
- Your fridge compartment is fitted with a fan-vent to help keep the temperature down in the compartment and so reduce the power consumption of the fridge. On hot days, you can also open the fridge compartment door but we recommend keeping the fridge inside the compartment when not in use to keep it shaded from the sun.



WARNINGS

See IMPORTANT warnings about your vridge on page 40 in the care and maintenance sections of this manual.

ABOUT YOUR EXTERIOR KITCHEN

Your OP15 kitchen is located on the door-side of the trailer in a slide-out compartment. The compartment is secured with lockable push-button latches.

The kitchen slide-out is held in place with spring-bolt locking pins. To open up the kitchen, pull the spring bolts in and turn them so they catch and stay open then slide the kitchen out to its full extension. You can then access the kitchen side quick connects for your gas and water connections (please see the kitchen sink and Gas system sections of this user manual)



- **Kitchen Sink:** please see the water system section for information on setting up your kitchen sink with water.
- **Kitchen Stove:** please see the propane system section for information on setting up your kitchen stove with propane and use.
- **Stove Wind Protectors:** The stove has two wind protectors that fold out to each side of the stove and secure in place with pins that slot into a hole on the kitchen surface. See the Propane Gas System for details on lighting the stove.
- **LED Light:** Position the flexible light to the desired position. Plug the power cord for this light into the small 12v socket on the exterior of the OP15. Ensure that the *Lights* switch is turned on so that the socket is receiving power. Be sure to disconnect the light from the outlet BEFORE sliding away your kitchen.
- **Support Legs:** Folded underneath the slide out kitchen is a swing-down support leg. Push the button catch to release the leg. You can adjust the height of the leg as appropriate by loosening the wing nut pins to release the telescoping leg and then tightening them to hold it in place. To fold the leg away, retract the extendable leg fully and push the black end of the button catch to re-secure. There is also a secondary removable support leg pole which has a groove in the top that the underside of the kitchen fits into. This pole is also adjustable. We recommend using these support legs each time you set up the kitchen.

STOVE NOT SPARKING? Below is a list of items to check

1. Is it clicking? Try replacing the Battery if not clicking
2. Can you see it visually sparking? If so, go to #3
3. Is the gray ignition disk in the right place – They can be sensitive to placement, please ensure it is centered correctly.
4. Is the correct black disc being used? These can get switched on the stove as they do appear to fit on multiple burners.
5. Try depressing the switch at a lower level – Setting the burner to low instead of the max/ ignition setting can assist
6. Are you getting gas to the stove? Can you light it with a lighter?

The OP15 comes fitted with a rooftop Dometic Penguin II 120v A/C unit.

- We strongly recommend that you read the instruction manual for this appliance in full before use for full instructions and maintenance information.
- The full instruction manual is provided with your trailer, or you can find it online using the provided QR code.
- Failure to follow the instructions may result in damage to the appliance which will not be covered under warranty.
- You must be connected to a source of 120v electricity via either shore power or a generator to run the A/C.

USING YOUR AC

- Ensure your A/C system is turned off if you are not connected to a 120v power source. You cannot run the A/C system off your batteries as it WILL DRAIN YOUR BATTERIES in a very short period of time.
- **There are two switches located inside the battery compartment labeled AC and Main. You must flip the “AC” switch in order for it to turn on.**
- In addition, your A/C system has a high wattage requirement to startup which your batteries cannot supply which may lead to damage to both your batteries and your A/C.



NO 120V POWER SOURCE?

If you are not connected to a 120v power source (either a shore power connection or a generator) the inverter will AUTOMATICALLY begin converting 12v current from your batteries to 120v to supply any connected appliances connected to the 120v outlets.

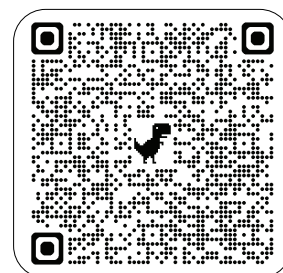

DOWNLOAD THE DOMETIC PENGUIN II USER MANUAL NOW:

TO OPERATE YOUR AC

- Use the left hand dial to select the fan or cooling fan strength.
- Use the right hand dial to select the temperature.
- Please keep all windows, doors and skylights closed for maximum efficiency when appliance is in use.

We strongly recommend that you read the instruction manual for this appliance in full before use for full instructions and maintenance information.



INVERTER & CHARGING

VICTRON INVERTER

The OP15 comes with the Victron MultiPlus 2000VA Inverter.

- This is a combined inverter and charger in one package.
- Its many features include a true sine wave inverter, adaptive charging and hybrid Power Assist.
- Ensure to turn off the inverter when not in use. Failure to do so will quickly deplete battery.

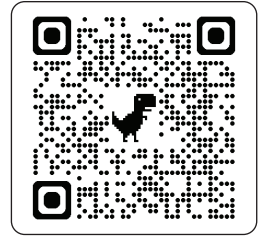

DOWNLOAD THE DOMETIC PENGUIN II USER MANUAL NOW:

Download Manual here: <https://www.opuscamper.us/download/21547/?tmstv=1721074259>

USING YOUR INVERTER

INVERTER SWITCH LOCATION

Your OP15 has a 12v to 120v changeover switch and inverter installed located in the battery compartment.

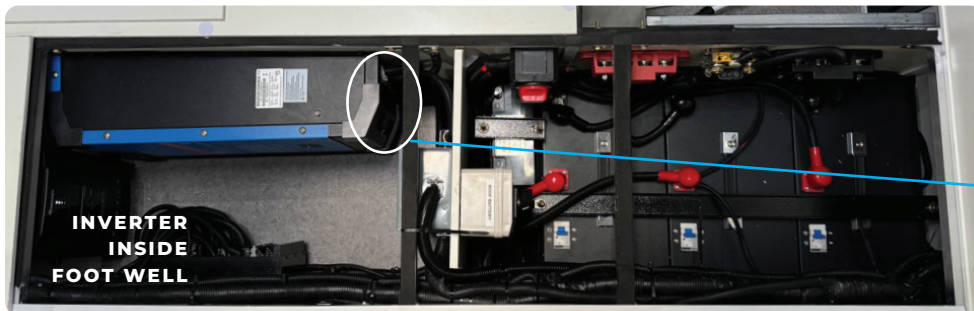

TURNING ON YOUR INVERTER

To turn on your inverter, make sure the power button on the side of the inverter is turned on.



INSTRUCTIONS:

- Always make sure to turn on the inverter switch in the Victron unit.
- If you connect to shore power, the inverter uses shore power as main source with the help of transfer switch (takes 30 seconds) and at the same time it will charge the batteries.
- For this inverter charger, there is no need to adjust the setting for the battery type.
- If you are not using the camper for a long time, turn off the inverter switch, the 300 A breaker switch, both 50 breakers, and the "Primary Seaflo Battery Switch" - This will ensure your battery won't draw any power while your trailer is being stored.



CHARGING YOUR TRAILER: SHORE POWER

- To charge your battery using shore power, you must flip the “Main” switch on inside the battery compartment.
- The exterior shore power hookup is located on the driver’s side at the front of the OP15. Your OP15 comes supplied with a 30 Amp shore power cable and pigtail connection for both campsite and home outlet connection. Ensure proper maintenance of the power cord and pigtail accessory items.
- Always use a Listed and approved 30 Amp cable and adapter and a ground-ed power source. Never use an extension cord.
- DANGER! Due to the potential danger to ignore this warning, the recreational vehicle manufacturer cannot be held responsible should damage, injury or death result from failure to connect the power cord to a properly ground-ed power source.



BREAKER PANEL

- Breaker Panel: The OP15 comes fitted with a 120-volt power system. This 120 Volt power system complies with NFPA and NEC regulations.
- The hookup for the 120v is located outside on the driver-side of the OP15.
- **The main circuit breaker panel is located inside the OP15 in the foot well.**
- If you’re experiencing issues with your power the first time you use your trailer check the breakers as they might be turned off in new units.
- Always ensure you have clear access to the circuit breaker panel and that it is not blocked at any time.

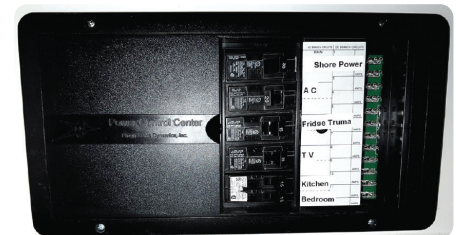

USING YOUR AC

- Ensure your A/C system is turned off if you are not connected to a 120v power source. You cannot run the A/C system off your batteries as it WILL DRAIN YOUR BATTERIES in a very short period of time.
- **There are two switches located inside the battery compartment labeled AC and Main. You must flip the “AC” switch in order for it to turn on.**
- In addition, your A/C system has a high wattage requirement to startup which your batteries cannot supply which may lead to damage to both your batteries and your A/C.



NO 120V POWER SOURCE?

If you are not connected to a 120v power source (either a shore power connection or a generator) the inverter will AUTOMATICALLY begin converting 12v current from your batteries to 120v to supply any connected appliances connected to the 120v outlets.

12V POWER POINTS

The OP15® has many 12v outlets that are a combination of standard 12v sockets, mini 12v sockets and USB sockets. There are also a range of 12v features included with the OPUS, all controlled by the main control panel, the locations of which are listed below. All switches have their own resettable breaker located above the switches.

- The internal 12v sockets and external 12v socket will operate on 12v power from the leisure battery; heavy usage and power-hungry appliances will deplete the battery's charge quickly.
- Inside the OPUS® there are four 12v mini sockets. These are for the 12v LED light strips.
- On the exterior, there is one 12v outlet on the main control panel and one by the slide-out kitchen. There are also two additional 12v mini sockets and a standard 12v socket. The two mini sockets are designed to operate the 12v LED light on the kitchen and a small canopy light. In the front tool box there is a standard 12v socket intended for use with the fridge. In the same area there is a small switch that operates the fan located in the door.



OTHER 12V FEATURES

- The trailer lights and electric breaks are wired to a standard 7 pin trailer plug. The OPUS® is fitted with electric breaks and require an in-car electric break controller installed to operate.
- The battery charger is fully automatic and will recharge the battery if the OPUS® is connected to an electric hook-up.
- The battery will also charge whilst in transit if the tow vehicle has the 7-pin connection and DC - DC charger.

RESERVING YOUR 12V BATTERY

- To reserve your 12v battery power we recommend unplugging all 120v appliances if you are not connected to the 30amp shore power hook-up (unless you are using them).
- These power-hungry appliances will deplete your batteries very quickly (even with the solar-assisted charging) so we recommend using this functionality sparingly.

MONITOR YOUR AMP METER

- Please pay close attention to your amp meter if you are running a 120v appliance via the inverter; try plugging each appliance in separately to check its amperage draw to help you better understand and manage your power supply.
- On the control panel you will find the main 12v ON/OFF switch. There are separate switches for the following 12v operated appliances and systems in the OP15: Fridge, Sockets, Lights, Water Pump.

CAMPING OFF-GRID no 120v shore power

- If you are camping off-site without 120v power then the length of time that your batteries will last will depend on how much 12v energy you use, how much solar power you are generating to recharge the batteries (see below "Solar Power" Section), the 'health' or condition of your batteries and in some cases the ambient temperature. Your control panel will show you how much power you are using and how much remaining power is in your batteries to help you manage your power consumption.

120 VOLT SOCKETS

The OP15 has 6 internal 120 Volt sockets and 1 external socket - Each socket is labeled inside the trailer:

1. Bed side storage: 120 volt sockets are located on each side of the bed.
2. Exterior: One 120 volt plug at the rear of the trailer, and one is located in the fridge compartment.
3. Interior Kitchenette - One 120 volt socket is located on your interior kitchenette.
4. Behind TV mount - There is one 120 volt plug located next to the internal television mount.



12 VOLT - SAFE OPERATING PROCEDURES

You will need to charge your batteries for at least 24hrs prior to each trip using a 120v shore power connection to ensure that they are fully charged. The main control panel has a battery volt-meter that will provide an indication of the charge level of your batteries. A fully charged battery bank will be indicated by a full battery symbol and the voltmeter reading around 13.7volts.

If you are at a campsite with shore power then we recommend connecting for the duration of your stay to keep your batteries fully charged. If you are camping off-site without 120volt power then the length of time that your batteries will last will depend on how much 12volt energy you use, the 'health' or condition of your batteries and in some cases the ambient temperature. Your control panel will show you how much power you are using and how much remaining power is in your batteries to help you manage your power consumption.

Your 12v system is controlled by the main control panel which is located behind the exterior panel to the left of the door. On the panel you will find the main 12v switch. There are separate switches for the water pump, lights, 12v sockets, Fridge and Heater (Optional). To supply power to these features, use the main power key and turn the 12v power on your unit and choose the associated switch.

LIGHTS

- The exterior lights can be switched from warm to cool to help deter bugs or improve lighting.
- In both exterior tool box/ fridge compartments there is an LED work light. This has an automatic on/off photo sensor.
- Inside the door there is a dimmer light switch that will control the interior foot well lights.
- Ensure the Plugs and Socket switches are active on your control panel.



BATTERY INFORMATION

- Battery type: 135ah Lithium Batteries
- Fuse size: 125ah (Please note that the label on your battery will show '125ah', this is the fuse size and not the battery capacity.)
- Best way to charge: Apply saturated charge to prevent sulfation; can remain on charge with correct float voltage.
- Charge methods: Constant voltage to 2.40-2.45V/cell, float at 2.25-2.30V/cell. Battery should stay cool -- no fast charge possible.
- Charge time: 14-16 hours.



MONITOR YOUR BATTERIES

- The OP15 has three 135ah Lithium Batteries installed as well as a fully automatic battery charge controller system. The Charge Wizard allows you to control your charge levels. You will need to charge your batteries for at least 24hrs prior to each trip using a 120volt shore power connection to ensure that they are fully charged. The main control panel has a battery volt-meter that will provide an indication of the charge level of your batteries. A fully charged battery bank will be indicated by a full battery symbol and the voltmeter reading around 13.7volts .



DRAWING CURRENT WITH LITHIUM BATTERIES

Low Current Draw from Battery: Current consumption of 0.7 Ah per month (1 mA) @12 V and 0.6 Ah per month (0.8 mA) @ 24 V. Especially Li-ion batteries have virtually no capacity left when discharged until low voltage shutdown. After shutdown due to low cell voltage, the capacity reserve of a Li-ion battery is approximately 1Ah per 100 Ah battery capacity. The battery will be damaged if the remaining capacity reserve is drawn from the battery. A residual current of 10 mA for example may damage a 200 Ah battery if the system is left in discharged state during more than 8 days.

CONVERTER & CHARGE CONTROLLER

- Your OP15 comes with the Rover Li 40A MPPT Charge Controller to monitor solar and maximize solar charge.
- The charge controller is located on the left panel inside the battery compartment.
- The Rover Li 40A MPPT Charge Controller protects the battery from being over-charged by the solar modules and over-discharged by the loads.
- The controller features a smart tracking algorithm that maximizes the energy from the solar PV module(s) and charge the battery.
- At the same time, the low voltage disconnect function (LVD) will prevent the battery from over discharging.



STORING YOUR BATTERIES

- If you are not keeping your OP15 plugged in whilst at home, we recommend that you disconnect your batteries to maintain good battery health.
- The OP15 also has a “Main Power Switch” that will prevent the trailer from using power while in storage.
- Please see the care and maintenance section for more information on this topic.



CO/LP ALARM

- The CO/LP alarm is wired directly to the batteries. This means that turning the power to the OP15 off on the control panel will NOT shut power off to the CO Alarm. Please follow the winterization process for battery care to ensure you are fully disconnecting the batteries during long periods of storage.



RESERVING YOUR BATTERY ON THE ROAD

- Always set your fridge to 'LO' before heading out on your trip and bring your fridge down to the 'LO' temperature using an outlet in your house. This will use less power from your battery and allow you longer off-site camping.
- Ensure fridge contents are already cool before placing them in the fridge and unplugging from shorepower. This will prevent your battery from depleting at the beginning of your trip.



600 WATT SYSTEM ON ROOF

- There are four 100-watt solar panels mounted to the roof of the OP15 with a 30amp solar charge controller installed.
- During the day with adequate sunlight, the solar panels will automatically trickle charge your batteries. We recommend reading the user manual for your solar panels & charge controller in full to understand the capabilities and settings for the solar panels and charge controller.



SOLAR PANEL PORT

- The OP15 has a solar panel port on the drivers side rear.
- This port allows a portable solar kit to be connected to charge the batteries.
- The port is wired directly to the battery and uses direct current (DC) electricity.
- All OP15 solar panel ports are adapted for Zamp solar panels.



OP15 PACKDOWN GUIDE

This section covers everything you need to know about packing down your trailer and preparing for travel.

Please see detailed instructions for your kitchen, heater, gas, electric and water systems in this manual.



STEP 1: Packdown Interior

- Ensure there is nothing in the way of the roof that will come down.
- Ensure all the fans are turned to the proper travel position as shown below. Failure to do so will result in damage to the fans and possibly your trailer.
- Turn off the stove and close the lids to the sink and stove - Ensure they are secure before travel.



**DO NOT LOWER ROOF WITH
FAN IN UP RIGHT POSITION**

- Ensure all windows and skylights are closed and the table is tucked up against the soar area and all cargo is securely stowed. Close all drawers and cupboards, and close and secure the bathroom door.
- Stow and secure the TV in the interior mount, in travel mode.
- Fold closed the main bed mattress. Stow the additional cushions.

STEP 2: Lower the Roof

- Ensure there is nothing in the way of the roof that will come down.
- Press the lower half of the black “Roof” button and hold until the roof is fully closed.
- Lock all four securing latches to secure the roof during travel.



STEP 3: Close Rear for Travel

- At the rear of the trailer, un-hook the latch clamps on the rear panel and slide open the two locking pins. Use the handle to push the rear end wall panel down into travel mode.
- Carefully raise the bed panel into the vertical position and slide the securing latches into place to secure the panel for travel.
- Using a helper to hold up the roof panel, close both side panels through 90 degrees then pull and turn the spring bolt handle to secure the side panels in place.

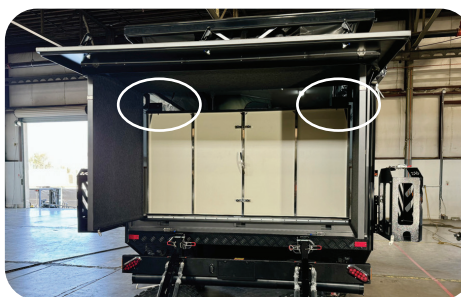
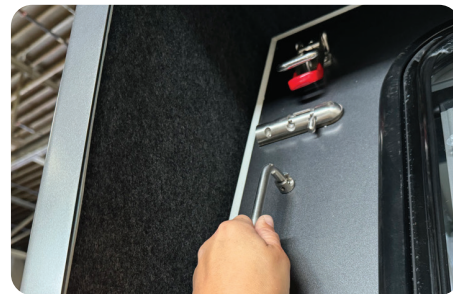

OP15 PACKDOWN GUIDE

STEP 4: Secure Jerry Cans for Travel

- Secure the red latch to the trailer.
- Insert the securing pin and latch both sides of the Jerry Cans.
- Release the securing spring to lock the cages for the travel position.
- Hock the Jerry Can to through the latch to secure it during travel.

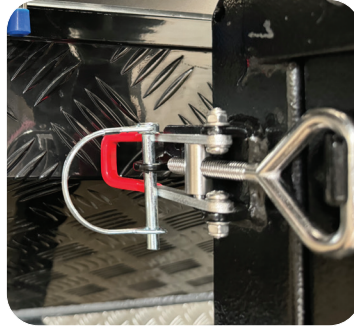

STEP 5: Secure Spare Tires for Travel

- Secure the red latch to the trailer.
- Insert the securing pin and latch both sides of the Jerry Cans.
- Release the securing spring to lock the cages for the travel position.
- Hock the Jerry Can to through the latch to secure it during travel.

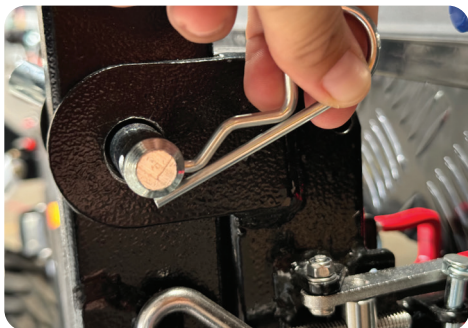
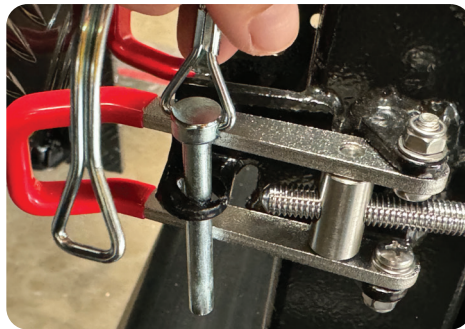
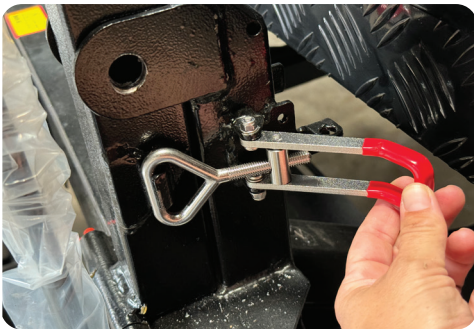

STEP 4: STOW YOUR KITCHEN

- Disconnect your water & gas quick connects from the kitchen as well as the 12v kitchen light.
- Ensure the water hoses are stowed in the drawer and that the drawers are closed on the catches properly. Stow the gas and waste water hose up through the aperture in the kitchen.
- Stow your kitchen support leg using the push-button retaining pin under the kitchen.

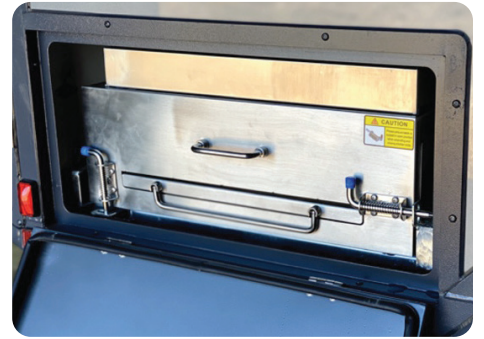

STEP 5: PREPARE FOR TRAVEL

- Fold over your cargo rack and secure with the latches. Twist down the triangle bolts to ensure a secure latch and secure the closed latch with the safety pin.
- Retract and fold up your stabilizer legs.
- Ensure all compartments are properly latched and locked.
- Connect to your tow vehicle making sure you lock the DO35 securing pin in place using the locking pin and ensure the vehicle side of your hitch is properly secure and locked to your tow vehicle.
- Retract your tongue jack wheel and hold up. Connect your safety chains, breakaway cable and 7-pin to your vehicle and complete your pre-trip checks to make sure your connection is

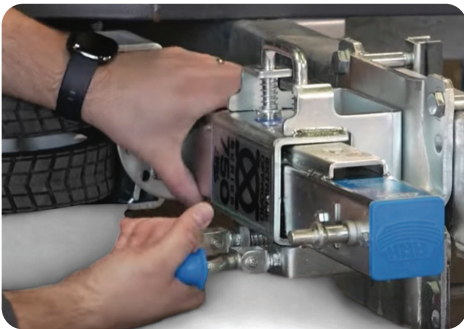

- Ensure all windows and skylights are closed and the table is tucked up against the soar area and all cargo is securely stowed. Close all drawers and cupboards, and close and secure the bathroom door.
- Stow and secure the TV in the interior mount, in travel mode.

SAFELY OPERATING YOUR GAS SYSTEM

The OP15 is fitted with a mount for 2x 20lb. Gas bottle. This bottle is to be connected to a gas regulator and turned off when the gas is not in use.

- **STEP 1.** To install a gas cylinder, place the gas bottle in the holder and use the provided clamp to hold the cylinder in place. Adjust the fit if necessary by turning the threaded triangle bolt. Ensure that you have the correct gas hose to connect the gas cylinder to the fixed gas regulator; your OP15 comes with a regulator-to-gas bottle pigtail hose which should be compatible with most US standard propane bottles.
- **STEP 2.** Once connected to the propane bottle, the gas tap/valve on the top of the gas bottle can now be opened.
- **STEP 3.** To connect the gas system on the kitchen; stowed under the sink there is a gas hose fitted to the stove that has a quick connect on the other end. Thread the gas hose through the aperture under the kitchen and connect to the gas quick connect on the side of the OP15. Turn on the gas tap on the gas quick connect on the side of the OP15 by turning 90° so that it is parallel with the fixture.
- **STEP 4.** To operate the gas stove; turn on one of the burners (push in, turn and hold to ignite). Keep pressing the button until the gas has had time to fill up the system and the burner will ignite. **You may need to hold the button in for up to 10 seconds before ignition to overcome the accidental ignition safety precaution in-built in the hob.** Do NOT lean across the burners to reach the stove controls. When the stove is not in use, please ensure the gas is turned off at the quick connect valve on the side of the OP15 and at the gas bottle.
- **STEP 5.** Ensure that the gas bottle valve is closed prior to packing up the OP15 for transit or storage, the quick connect valve on the side of the OP15 has been closed and that the gas hose has been disconnected from the side of the OPUS and carefully stowed inside the kitchen. Please make sure that the gas hose is fully inserted into the kitchen before sliding the kitchen into the storage compartment. Failure to do so can lead to the gas hose getting caught in the runners which can lead to damage.

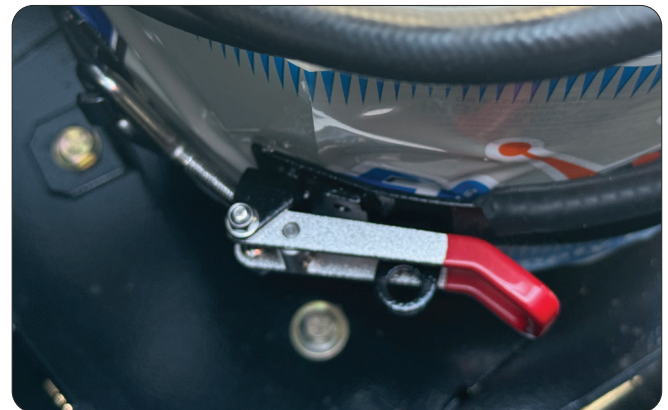
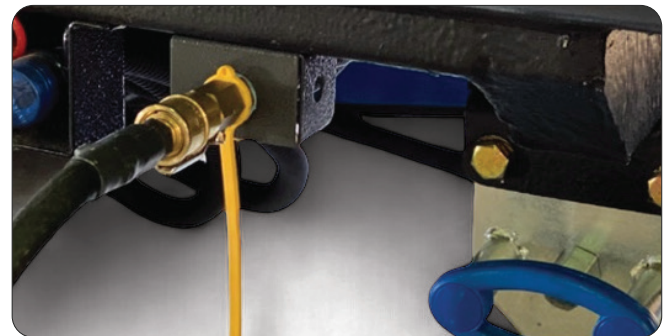

WARNING: Do not use any other gas systems than those provided with the OP15. Always turn off the shut off valve IMMEDIATELY after use.

PROPANE (LP) / CARBON MONOXIDE (CO) DETECTOR

- Your OP15 comes fitted with a propane (LP) / Carbon Monoxide (CO) detector installed directly wired to the battery.
- Please read the user manual supplied for the detector to fully understand correct usage.
- If the Propane or Carbon Dioxide warning alarm sounds, evacuate the trailer immediately and, if safe to do so, close off and fully disconnect the propane tanks.
- Do not touch any electrical switches. Follow proper and safe steps to ventilate the trailer and await for the alarm to stop before returning to the trailer then disconnect the 120v shore power connection and turn off the 12volt power.
- If you suspect any chance of a propane leak, fully disconnect the propane tanks and make an appointment to have your OP15 serviced with your dealership. Do not use any other gas systems than those provided with the OP15 . Always turn off the shut off valve IMMEDIATELY after use.



WARNINGS

Warning! Do not place propane cylinders inside the vehicle. Propane cylinders are equipped with safety devices that relieve excessive pressure by discharging propane to the atmosphere. Propane gas is highly flammable. Can lead to a fire or explosion and result in death or serious injury.

Danger! Do not use gas cooking appliances for comfort heating. Can lead to carbon monoxide poisoning, which can lead to death or serious injury.

Warning! Gas cooking appliances need fresh air for safe operation: before operating: open vents or windows slightly or turn on exhaust fan prior to using cooking appliances. Gas flames consume oxygen, which should be replaced to ensure proper combustion. Improper use can result in death or serious injury.

Warning! Do not fill propane container(s) to more than 80 percent of capacity. A properly filled container contains approximately 80 percent of its volume as liquid propane. Overfilling propane container(s) can result in uncontrolled propane flow, which could lead to a fire or explosion and result in death or serious injury.

Danger! If you smell propane:

1. Extinguish any open flames and all smoking materials.
2. Shut off the propane supply at the container valve(s) or propane supply connection.
3. Do not touch electrical switches.
4. Open doors and other ventilating openings.
5. Leave the area until the odor clears.
6. Have propane system checked and leakage source corrected before using again.

Ignition of flammable vapors could lead to a fire or explosion and result in death or serious injury.

Warning! When using the outdoor cooking area, the vehicle must be level and stabilized. Do not violate manufacturers' instructions on required clearances for cooking appliances during use. Do not store cooking appliances until cool to the touch. Can lead to a fire and explosion and result in death or serious injury.

Danger! Gas fumes inside a camper trailer could result in unconsciousness, brain damage or even death. Follow safe operating procedure with gas at all times: ensure good ventilation at all times.

Danger! Check the instructions for correct fitment and safe use with the gas cylinder manufacturer/supplier.

Danger! Always ensure that the gas cylinder retaining straps are fitted whenever a gas cylinder is installed in the front locker compartment, even when the opus® is stationary.

Important! Please consult the opus team before completing any repair work on the gas system: the propane system installed includes a 2-stage regulator. The regulator must always be installed with the vent facing downwards.

The regulator is located on the front of the OP15. Ensure that the vent for the regulator is not obstructed as blockages could result in excessive propane pressure causing fire or explosion

The propane system of the camper is designed for use with the supplied stove only; do not use any other gas appliance with it. The propane system is designed for use with propane only. Do not use other forms of gas.

Portable fuel-burning equipment including but not limited to wood & charcoal grills and stoves shall not be used inside the camper due to risk of fire or asphyxiation

TRUMA COMBI ECO HOT WATER & HEATING SYSTEM

TRUMA COMBI ECO HOT WATER & HEATING SYSTEM

The OP15 comes with the Truma Combi Eco hot water & heating system installed. This system is run off of your 12v power and propane gas supply. The system will provide hot water for your exterior shower and kitchen sink as well as forced hot air into the trailer.

We strongly recommend that you read the Truma Combi System manual that is provided with your trailer thoroughly before use for full instruction on how to operate and store/winterize this appliance. Failure to follow the instructions in the Truma product user manual may result in serious injury or death. Damage caused by failure to follow the instructions will not be covered under warranty. In the event that you cannot find the manual, please visit www.truma.net/heating-systems/truma-combi-eco for a digital copy of the user manual.

The Truma system is installed in the interior compartment across from the entrance. To turn the Truma Combi system on ensure your power and propane are both turned on. Use the Truma control panel located on the exterior of the storage compartment housing the Truma Combi to set the desired temperature.

The Truma system can be used to provide either hot water only, forced hot air only or both concurrently. Please note however that using both the water heater and the forced hot air system at the same time will reduce the efficiency of both systems and cause the water to take longer to heat up..

Ducts for the forced hot air system can be found inside the OP15. There are three circular outlet vents to exit hot air and one rectangular vent for return air inlet.

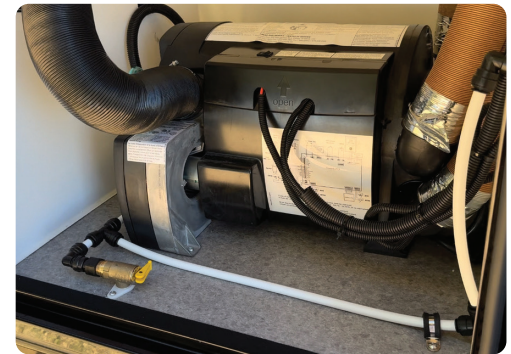

WATER HEATER

The Truma has a 2.64gl holding tank capacity and uses water pumped directly from your potable water tank. The water will take approximately 20-25 minutes to reach temperature.

The Truma provides hot water to the following appliances:



WINTERIZATION:

1. To winterize your water heater, you will need to access the three way valve inside your trailer.
2. It's located in the storage well with your inverter.
3. You will see an enclosed white wall with a black lid labeled "Winterization"
4. You will need to remove the three screws to access the winterization valve.

Use the provided QR code for all Winterization guidelines

Please See The Truma Combi Full Winterization Guide In The Care & Maintenance Section.



WARNINGS

- WARNING! Please keep all interior vents (air intake and exit) free of obstruction at all times. You must also keep the exhaust vent on the exterior front of the trailer free of obstruction too.
- WARNING! Scalding injuries are caused by hot water! Water temperatures over 127 °F (52 °C) can cause severe burns or scalding and in extreme cases even death. Always test the water temperature carefully before use.
- WARNING! FIRE OR EXPLOSION HAZARD - Failure to follow safety warnings exactly could result in serious injury, death or property damage. Do not store or use gasoline or other flammable vapors and liquids in the vicinity of this or any other appliance.

WARNINGS

WHAT TO DO IF YOU SMELL GAS:

1. Evacuate all persons from the trailer,
2. Shut off the gas supply at the gas container or source,
3. Do not touch any electrical switch, or use any phone or radio in the trailer,
4. Contact the nearest gas supplier or certified service technician for repairs.
5. If you cannot reach a gas supplier or certified service technician, contact the nearest fire department.
6. Do not turn on the gas supply until gas leaks have been repaired.

WARNINGS - HOT WATER

- The Hot Water Shower is capable of producing scalding water temperatures. Please take care to ensure your safety and those around you when in use.
- WARNING! The exhaust gas and top of the Hot Water Shower is HOT! Do NOT place hands or objects near the top of the heater. Always allow the Hot Water Shower to cool before dismantling and stowing. Always dismantle the Hot Water Shower before moving your OPUS® Camper.

IMPORTANT:

- IMPORTANT! Use only with propane. If you smell gas, turn off the gas valve at the tank immediately.
- IMPORTANT! Always turn off the Hot Water Shower using the main power switch AND the propane flow at the Quick connect AND turn off the electric rear water pump at the control panel.

WATER SYSTEM - POTABLE

SINGLE PUMP WATER SYSTEM - SEAFLO 12V PUMP

12V WATER PUMP

The OP15 is fitted with two 31 gallon fresh water tanks mounted under the OP15 towards the middle and rear of the trailer. The water tanks have two fill points located on the driver-side of the OP15 and identified by a blue water faucet icon.

Your water tank is connected to the 12v water pump which can be switched on via the main control panel.

- The water pump is pressure operated, so once the main power switch is turned on at the control panel, the pump will prime the system.
- As soon as you turn the tap on the water will flow. Once the tap is closed, the pump will turn off until the tap is back on.
- The kitchen has a drain hose attached to the sink drain.
- This is designed to drain to a waste water container or bucket.

YOUR OP15 HAS A SHOWER ON THE DRIVER'S SIDE REAR.

WATER TANK GAUGES

You can use the water gauges on the main control panel to check the water levels in each tank. The tanks are gravity filled and included with your OP15 is a potable water fill hose which should also be sanitized regularly. It is important to monitor the water levels in your tanks.

When your water tanks are empty please turn off your water pump. Running your pump without water in the tank will cause your water pump to burn out. Please see the Troubleshooting section for tips if you are not able to draw from your potable water tanks.

WATER TANK SELECTOR LEVER (BLUE BALL VALVE)

You can set your water pump to draw from EITHER the front OR the rear tank OR from both tanks. To do this, locate the selector lever located under your OP15, behind the driver-side wheel. You will see a blue lever at a junction of three water pipes. To select the FRONT tank, move the lever through 90° towards the F marking in the direction of the rear of the trailer. To select the REAR tank, move the lever towards the R marking in the direction of the front of the trailer.

To select BOTH tanks move the lever to the center of the markings, so that the red arrows line up with the three water pipes. Please note if either of your water tanks is EMPTY please move the selector to the other tank and do not leave it on BOTH tanks.



DRAINING YOUR POTABLE WATER SYSTEM

Located on each potable water tank you will find a draining valve at the lowest point of the tank. When packing away the OP15 complete the following process to drain the system of any excess water.

1. Switch off the pump on the main control panel
2. Open the faucet & allow the excess water in the pipe to drain
3. Close the faucet once all of the water has drained.
4. Disconnect either side of the quick connect
5. Ensure the sink is emptied and that the waste water drain hose is empty before folding it back into the kitchen.
6. Please refer to the steps in the care and maintenance section of this user manual for more information on draining and preparing your tanks for storage.

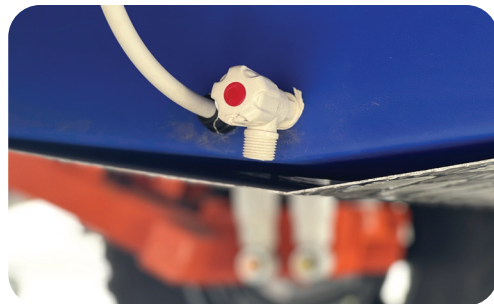

PACKING DOWN YOUR WATER SYSTEM

Located on each potable water tank you will find a draining valve at the lowest point of the tank. When packing away the OP15 complete the following process to drain the system of any excess water.

- The rear tank also has a quick-access valve to on the side of the tank to allow quick drainage for better towing balance at the end of your trip in the case that your front tank is more empty than your rear tank.
- Please note that for long periods of storage we recommend using the low-point drain on the BOTTOM of the water tank to fully drain your tank of water.
- Please refer to the steps in the care and maintenance section of this user manual for information on draining your tanks and preparing your tanks for storage.
- **IMPORTANT!** A small amount of water may be present from the connectors and waste hose so a cloth is useful to remove any excess water.

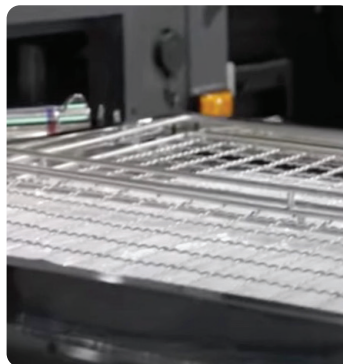

EXTERIOR SHOWER

Hot Water Exterior Shower And Tent:

Your OP15 has a fold-out shower/privacy tent installed on the rear driver's side.

There is a shower box about 5 feet under the tent that connects to the tent giving you access to the shower head and temperature gauges.

Shower Tent

1. There is a fold-out shower/privacy tent on the rear driver's side.
2. Unzip the storage bag mounted to your trailer and roll down the tent.
3. Extend all four arms until the tent is fully extended.
4. Use the straps at the top of the shower to adjust it lower or higher from the ground.
5. There are additional straps at the bottom corners of your tent to secure it with stakes.

Shower Box

1. There is a shower box about 5 feet under the tent.
2. Unlock the Shower Box to access the shower head and temperature gauges.
3. Unzip the small entrance spot on the back of the tent.
4. Run the shower nozzle and hose through the unzipped entrance point and secure it to the velcro loops.

Running Hot Water To Your Shower

1. The Truma Combi will need to be on to run hot water.
2. Hot water requires propane - Ensure you are properly connected.
3. Ensure the "Pump" switch on the main control panel is on to receive water to your shower.



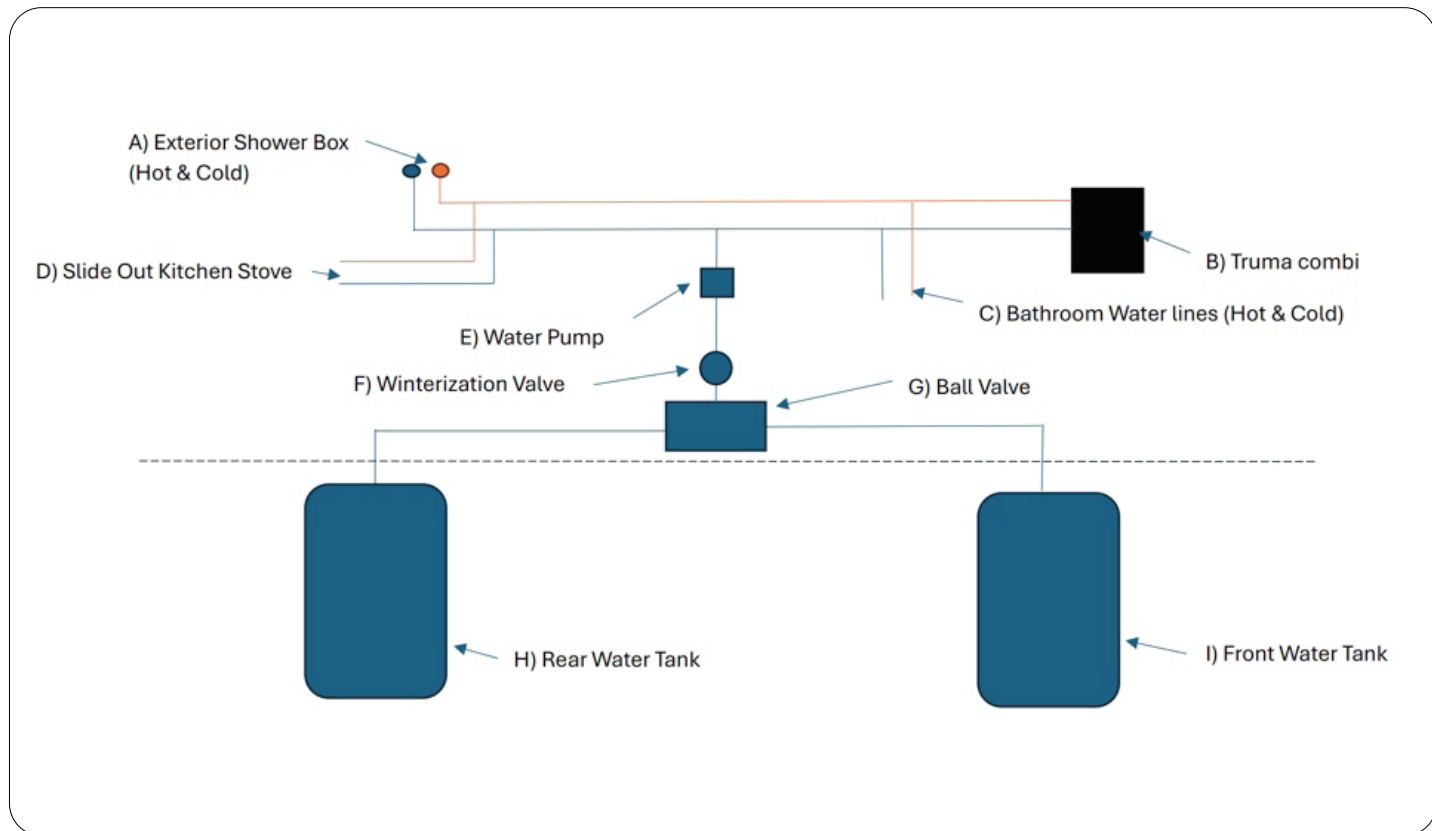
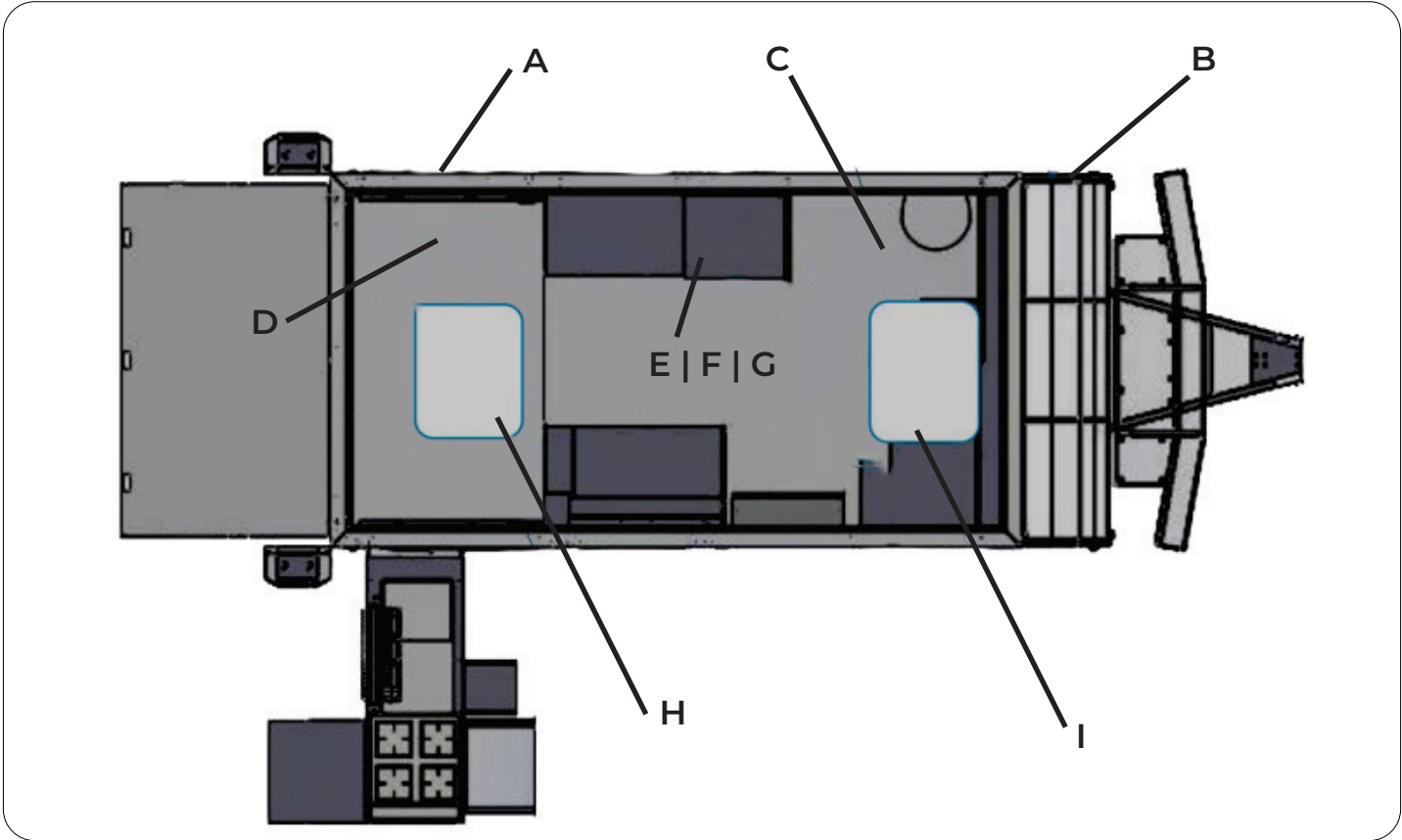

WATER SYSTEM - GREY & BLACK TANKS

GREY WATER SYSTEM

- The OP15 gray water tank has a capacity of 17 gallons and is the front most tank on the underside of your trailer. It collects the gray water from your shower and bathroom sink.
- Please note that your kitchen sink does not drain into the gray water tank. Please visit the Kitchen section of this manual for more information on the kitchen sink drain.
- You should continually monitor the fill level of your gray tank using the gauge on the main control panel during use.
- We recommend emptying your gray tank when it is around 3/4 full.
- You will find the gray water drain outlet on the gray water tank.
- Please remember to dispose of gray water safely at dumping stations or other permitted outlets.



STORING YOUR GREY TANK

- Only liquid run off from the shower and sink should be drained into your gray water tank. No other liquid is permitted to be drained into the gray tank.
- It is important to regularly clean your gray water tank as a build up of grease, dirt and soap scum can impact the function of the tank and cause odor.
- Please see refer to the OP15 Care and Maintenance section of this manual for proper cleaning steps and for cleaning and draining prior to storage.
- Do NOT use bleach to clean your gray water tank.

BLACK WATER SYSTEM

The OP15 black water tank is located towards the front of the trailer on the lower edge of the driver's side. It can be identified by the black tank drain valve. The capacity of the tank is 10 gallons and the fill level can also be monitored using the gauge on the main control panel.



EMPTYING YOUR BLACK TANK

- We recommend emptying your black tank when it is at least 1/2 to 3/4 full and after every camping trip. Emptying your tank sooner may result in solid waste being left behind in your tank; a fuller tank allows more opportunity for breakdown of solid waste.
- All waste from the OP15 toilet is collected in the black tank so please take caution when emptying to avoid contact with waste which can carry harmful bacteria. The black tank must ONLY be disposed of in designated dump stations.
- **At the rear of the trailer is a holding tube for the black tank drain hose.**



STEPS TO EMPTY BLACK TANK

Please refer to the steps in the care and maintenance section of this user manual for more information on draining and preparing your tanks for storage.

1. Switch off the pump on the main control panel
2. Open the faucet & allow the excess water in the pipe to drain
3. Close the faucet once all of the water has drained.
4. Disconnect either side of the quick connect
5. Ensure the sink is emptied and that the waste water drain hose is empty before folding it back into the kitchen.
6. Remove the black tank hose from the storage tube by twisting the cap off
7. Connect the drain hose to the drain valve by twisting on to receiver hooks
8. Ensure the other end of the drain hose is directed into the appropriate dump point.
9. To empty, pull the valve to open.
10. Leave the valve open until you can no longer hear liquid waste draining then close the valve completely. Close the valve at this point.

BLACK TANK TIPS

1. You can also use Formaldehyde-free black tank treatments such as the Camco TST Drop-ins to help breakdown waste and prevent odors.
2. If you are on-site camping and connecting to a campground sewer we recommend keeping the tanks drain valve closed until you need to drain to assist in purging the tank of solid waste.
3. Please see the 'Bathroom' section of this manual for more information on using your toilet.

WARNINGS!

- Do NOT leave waste in your tank during storage.
- Only use potable water from a reliable source in these tanks. Do NOT store water in the tanks for more than two weeks.
- Sanitize, flush and drain the water tanks before using and a minimum of every 6 months.
- If you suspect there's an issue with the quality of your water, flush and drain your tanks.
- Do NOT use bleach to sanitize the tanks, as they will cause corrosion to the stainless steel.
- See the OPUS Care & Maintenance section of this manual for more information on sanitizing your water system.
- Failure to maintain your tank can result in death or serious injury.
- Please turn off your pump at the main control panel when the water system is not in use as they will continue to use battery power when they are turned on but not in use.
- Do not run your water pump when the tanks are empty as this could cause the damage to the water pump and circuit.
- Please note if either of your water tanks is EMPTY please move the selector to the other tank and do not leave it on BOTH tanks.

TOILET

- The OP15 toilet is a two-step flush toilet, connected to the potable water tank.
- In order to flush the toilet, first push the pedal (located on the right-hand side of the toilet base) down HALF WAY. This will fill the toilet bowl with water from your potable tank.
- Next, push the pedal down all the way to empty the toilet bowl. It is very important to complete the two steps including filling the toilet bowl with water, in order to ensure adequate water in the black tank allowing the break down of solid waste to facilitate the thorough emptying of the tank.
- Do NOT throw trash or kitchen waste down the toilet as it will not break down in your black tank and can lead to clogging of your drain and interfere with the tank fill sensor.
- Storage: Keep cells at >2.05V. Apply topping charge every 6 months to prevent sulfation.
- Disposal: Toxic. Do not dispose. Electrolyte corrosive. Profitable to recycle.



TOILET TIPS

- Only use single-ply RV toilet paper which breaks down faster
- • Sparing use of toilet paper also means less solid waste to dissolve
- • Always add water to the toilet bowl before flushing and flush regularly
- • Compress the pedal smoothly and evenly to avoid damage
- • Continually monitor your black tank level during your trip
- • Keep toilet lid closed when not in use to help minimize odors from black tank

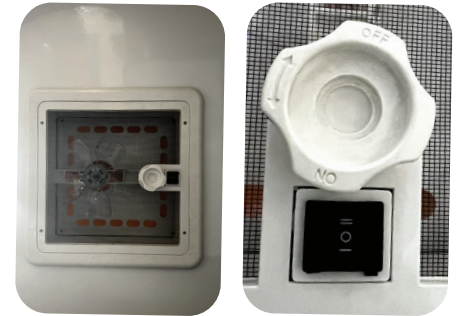

SHOWER

- The OP15 shower draws water from your potable water tanks and drains to the gray water tank.
- In order to receive hot water to the shower, you must use the Truma Combi System.
- *Please refer to the Truma Combi System section of this user manual.*
- Do NOT plug or clog the shower drain.
- Take care to remove debris and hair from the drain in order to prevent flooding of the bathroom stall and unnecessary debris build up in the gray water tank.
- Be sure to clean the shower and controls regularly to prevent the build up of soap scum and limescale from impacting the effective function of the shower.



SHOWER TIPS

- IMPORTANT! Ensure the 12v fan on the ceiling of the shower is on when the shower is in use to prevent a build up of steam and moisture inside the shower room and camper. A build-up of steam can lead to light-headedness, loss of conscious and falls.
- IMPORTANT! Water may be hot. Always test the heat of the shower before stepping into the shower flow.
- IMPORTANT! The floor of the OP15 may become slippery when wet. Take care to keep water from the shower inside the shower room. Make sure the door, including the tent section is closed when the shower is in use and any spilled water is dried immediately.

SINK

- The sink on the OP15 is a mixer tap and draws water from your potable water system.
- To receive hot water to the sink, please follow the steps in the Truma Combi System section.
- Take care to test the heat of the water from the faucet as water may be hot.



UNDER YOUR SINK

- You can access the plumbing under the OP15's bathroom sink.
- You can access your water lines and drainage via this door.
- Take care not to store



TELEVISION INDOOR/OUTDOOR 12V TV

INTERIOR SET-UP

- To use the TV, ensure the 12volt power is turned on and that the TV is connected to the 12volt power socket AND the aerial socket located next to it on the side of the wardrobe. In the top drawer beneath the TV you will find the remote and manual for the TV.
- Please refer to the TV manual for further information on setting up your TV.
- Please note that the TV channels do not come pre-set so you may need to set the TV up to scan for local channels. This may apply for each journey you take in the OPUS, depending on channel coverage.



EXTERIOR MOUNT

- There is also an exterior mounting point for the TV located between the Kitchen and the prep-deck. To move the TV from the interior mount please first ensure all wires are unplugged from the outlets inside the trailer.
- To remove the TV from the bracket push the hooked clip at the bottom of the mount and slide the TV and the adjustable arm up to release from the tracks in the mount.
- To mount the TV to the exterior bracket slide the adjustable arm down into the tracks of the exterior TV mount until it clicks into place. Connect the two 12v power cables and the aerial cable to the outlets under the weatherproof protective cover.



ANTENNA AMPLIFIER / DIGITAL BOOSTER

Your OP15 comes with an antenna amplifier that connects to the coax cables of your existing antenna installation.

WARNING

- Always mount the TV to the interior mounting point during travel and use the installed straps to help to keep the TV secure.
- Do not use the TV on the exterior mount in wet weather even with the awning extended.



ABOUT YOUR WINDOWS

- There are six windows solid-pane openable windows in the OP15 as well as zip-vent windows in the tent material of the roof.
- Each solid-pane window has two optional screens.
- In addition to the standard clear window mode; a mesh insect screen & an opaque curtain screen.

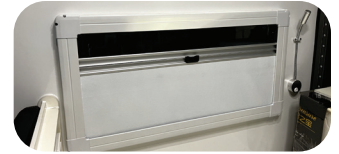

OPERATING YOUR WINDOWS

STEP 1

Slide the lower silver screen bar up to reveal the curtain screen.



STEP 2

As shown in the image, press the bottom of the clasp to lever the hook up.



STEP 3

Hook the clasp over the lip of the top silver screen bar.

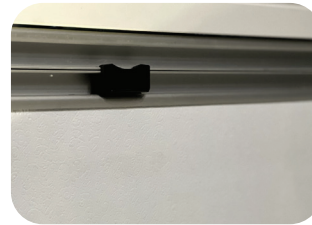

STEP 4

To release, press the clasp again and release the hook. Slide the top silver screen bar down to reveal the mesh insect screen & lock in the same way.



WINDOW CLASPS

The black clasp located on the center of the lower silver screen bar is used to lock the screens in place.

WINDOW LATCHES

- Turn latches through 90° to clock/unlock.
- The solid-pane windows are openable, hinged along the top edge.
- There are locking latches on each window.
- These latches also allow you to open the window to a 'vent mode' by latching on the secondary latch.
- Remember to close fully for storage.



TO OPEN WINDOWS

- To open, push the window outwards from the bottom.
- Gas struts will hold the window in place at the point they are opened to.

TO CLOSE WINDOWS

- To close the window, push it all the way open until you hear an audible 'click'.
- This will release the gas strut and allow you to close the window.
- *Note some of the latches may have a release button in the center of the latch that needs to be pressed in order to turn the latch.



FRONT DOOR

The entrance door is fully lockable from outside with the key provided and from inside using the red lock latch.

There is also a screen door for to protect against insects and provide ventilation.

The screen door can also be unlocked using both an external key or the interior black latch on the door handle.

There is also a slidable panel to allow you to close off the door handle access panel when using just the screen door.

The OP15 comes with a snap on black-out shade for the front door.



SKYLIGHT WITH LED LIGHTS

- The skylight features a set of LED lights that can be controlled with the integral ON/OFF switch on the light itself.
- The Skylight can be opened by turning the two black locking handles through 90° and then pulling the white handle down to release it from the holding catches then pushing upwards to open the window.
- To close the window, simply pull the white handle down and up into the holding catches.
- The skylight also has both a black-out blind and a mesh insect screen. These screens simply slide out across the window (one is located at either side).
- Please note that if you slide the screen fully across to meet the screen on the other side, they will join via a magnet in the middle.
- To release, gently pull them apart.
- Please ensure that the skylight is closed when rain is expected.
- Do not leave your OP15 unattended with the skylight open. Do not store your OPUS with the skylight open.

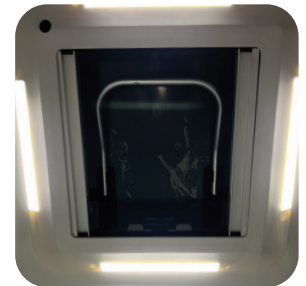

REAR BACK-UP CAMERA

The primary camera (backup cam) runs off 12V power

1. To power the primary camera: Turn on your control panel's Power and Socket buttons.
2. To power the receiver: Connect the receiver to the 12V socket connection.
3. Pairing the primary camera to the receiver: The receiver usually automatically pairs with the camera. If not, you must follow the steps to pair to the camera manually.



NEW TRAILER MAINTENANCE

TRAILER BRAKES

Your electric drum brakes require a break-in period to achieve full and proper performance. This applies when you first receive your new OP15 then after new parts are installed as part of your maintenance schedule. Your OP15 brakes should be adjusted after the first 200 miles then every 3000 miles after that. We highly recommend that all brake adjustments, maintenance and ser-ving is carried out by a qualified technician at your OPUS dealership.

CAUTION! You may need to adjust your brakes more frequently dependent on variations in cargo weights.

SUSPENSION, WHEEL & HITCH BOLTS

After your first 50 miles then 500 miles after that please check the suspension bolts, wheel nuts and hitch bolts to ensure that they have maintained their tightness.

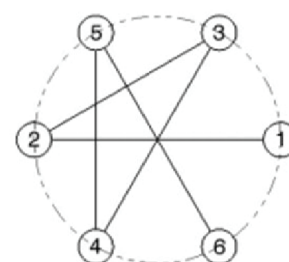

6 LUG BOLT
PATTERN

STEP 1: This should be completed with a torque wrench to 100 ft lbs.

STEP 2: When tightening wheel nut lugs, please tighten bolts in a star pattern as indicated in the diagram.

STEP 3: After that, check your bolts every 2000 miles and always before an extended trip.

FIRE, LIFE & SAFETY DEVICES

Your OP15 is fitted with a number of fire and life safety devices and comes with manuals and instructions for operating each device. These include:

1. PROPANE GAS & CARBON MONOXIDE ALARM—Locate in the footwell directly opposite the main door
2. SMOKE ALARM—located on the wall just inside the door to the right
3. FIRE EXTINGUISHER—located inside and to the right of the door.
4. EMERGENCY EXITS - Are shown on the below floorplan.

WARNING: Failure to regularly test and properly maintain these devices may lead to serious injury or death.

WARNING: The following label has been placed on the interior of the main entry door and reads as follows:

WARNING: Do not utilize this RV unless fully set up because a secondary means of escape is not available.

EMERGENCY EXITS ARE SHOWN ON THE OUTLINED FLOORPLAN

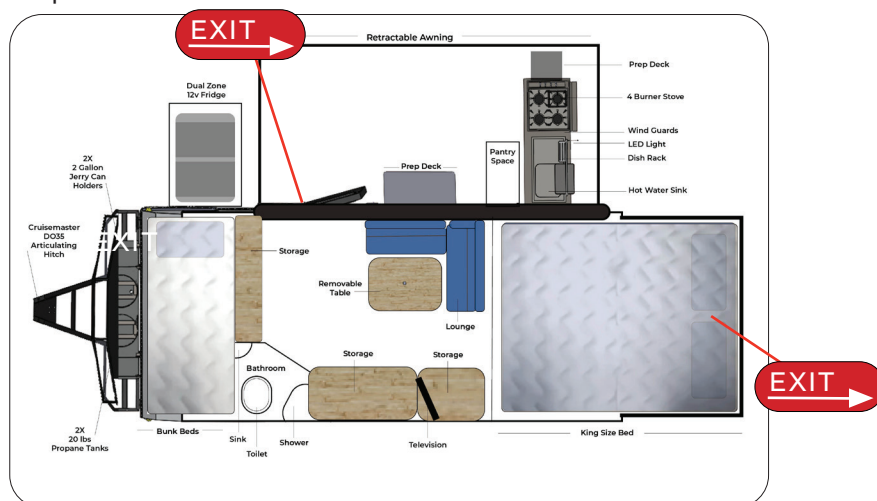

GREASING & SERVICING

- The electrical and propane systems will need to be checked over by an RV service technician. The lug nut torque requirements are 100ft lbs.
- **WARNING! Never use the levelling jacks to lift the trailer completely from the ground for any reason including servicing, repair work or tire changes. To do so would cause the trailer to become unstable and unsafe. Always use proper lifting equipment or have the work completed at an approved service location.**
- The servicing schedule may be affected by your usage amount and operating conditions. Discuss your intended use and servicing timetable with your dealership to find the optimum schedule for your OP15. It is always better to attend to or catch small problems early or before they occur rather than allowing problems to become larger or impact other systems or areas of your trailer. Failure to service your trailer in a timely manner may mean that issues may fall outside of or void your warranty due to failure to complete proper maintenance (neglect).

The servicing requirements are:

- Check the wheel bearings every year - ensure these are checked by a qualified service technician.
- Check the lug nuts every 2000 miles - this includes the spare tires nuts.
- Check the tire pressure every 2000 miles - the tire sticker on the interior of the door will supply the appropriate pressure.
- Have the dual coil suspension serviced every year; a dealership will complete the following services:
 - Check and ensure the Zerk fittings on the suspension are in good condition and that these are removed and the suspension well oiled.
 - Utilize a grease gun kit and some Moly-Grease .
 - Check that the coil suspension is well greased (Moly-Grease suitable for suspension coils will also be acceptable here).
 - Grease the hitch with some compound similar to Reese Heavy Duty Hitch Lubricant .
 - Winterize the water tanks (see water system care & maintenance section).
 - Look for signs of chipped paint around the body work. We can supply a cover paint kit to dress this.

BATTERY CARE & MAINTENANCE

We have spec'd the Opus so you have the ability to leave your Opus plugged in without the need to remove the 30ah cable. We have done this for easy battery maintenance and care to protect your batteries from being completely depleted over long periods of storage which can cause your batteries to degrade faster.

OPTIONS FOR WINTERIZING YOUR BATTERIES:

We recommend periodically checking your camper or batteries during storage to ensure your chosen storage option continues to work appropriately. Batteries that are not stored appropriately and are allowed to fully discharge may need additional charging outside of your OPUS as the battery charger will not work below a certain voltage. Batteries that are left to discharge below 12volts may get damaged and not hold charge properly going forward. This damage is not covered under your OPUS warranty.

12V FRIDGE WARNINGS

- **WARNING!** Ensure the spring-bolt locking pins are locked in place AND that the pushbutton locks on the door of the compartment are correctly closed and locked prior to travel. Failure to do so could result in serious injury and damage.
- **WARNING!** Please make sure the spring-bolt locking pins are in the extended position at all times when the kitchen is set up so that the spring is not compressed. Failure to do so could result in serious injury. Take care to compress the locking pins again when closing the kitchen.
- **WARNING!** Please ensure that all cords and hoses are disconnected and retracted prior to closing your kitchen to avoid damage.
- **IMPORTANT!** Do not position the light over the stove. Always make sure that the power cord is removed from the outlet BEFORE sliding the kitchen away for storage to avoid damage to the light and the outlet.

WINTERIZING YOUR BATTERY

OPTION 1: MAIN POWER SWITCH

- If you are not keeping your OP15 plugged in whilst at home, we recommend that you disconnect your batteries to maintain good battery health.
- The OP15 also has a “Main Power Switch” that will prevent the trailer from using power while in storage.
- This is the easiest way to store your battery for long periods of time; however, if the Main Power Switch is no functioning properly, please follow on of the below options:



OPTION 2: TURN OFF BATTERIES MANUALLY

- Each battery has an “Off Switch” at the top.
- Turn each switch to “Off” position for long periods of storage.

OPTION 3: PLUG IT IN

- You have the ability to leave you OPUS plugged in without the need to remove the 30ah cable.
- If you’re depending on shorepower for long term storage, you must have the inverter and main “On” switch turned on. (Please see battery procedures.



POTABLE WATER SYSTEM

Please ensure you sanitize, flush and drain the water tanks before first use and after any period of storage. To maintain the cleanliness of your potable water tanks please ensure all water is flushed from your potable water tanks after each trip or every two weeks when in use. Do NOT store water in the tanks for more than two weeks.

TO DRAIN YOUR POTABLE WATER SYSTEM:

1. Turn off the water pump
2. On bottom of both potable water tanks is a drain plug. Open this plug to allow remaining water to gravity drain. Ensure water is collected and disposed of in a responsible way.
3. Ensure the drain plug is closed again before re-fill the tanks.
4. Open your faucets/ shower / flush your toilet (you may need to step on the toilet pedal several times to flush the toilet system fully) and allow any residual water to drain. Close the faucets again.

We strongly recommend sanitizing your potable water tanks at least once every six months. If you suspect an issue with the quality of the water in your tanks or notice discoloration, odor or foul taste you should sanitize immediately. Always check your potable water source and use a fill hose listed for use with potable water.

TO SANITIZE YOUR POTABLE WATER SYSTEM:

1. Flush all water from system as detailed above
2. Use a potable water sanitizing product such as Camco TastePURE Spring Fresh Water System Cleaner
3. Do NOT use bleach to sanitize the tanks as they are stainless steel and it will cause corrosion
4. Follow the steps as directed on your potable water sanitizing product to fill, sanitize and purge as required.

WINTERIZING YOUR POTABLE WATER

As a reminder, the OP15 is not a 4-season camper and as such should not be subjected to freezing temps without after-market heating pads/ insulation kits added (something we do not offer as an option).

Please follow the instructions on the label carefully to determine the correct dilution or amount of fluid to use. **DANGER!** Do NOT use automotive antifreeze to winterize your potable water system as they are highly toxic and ingestion may leave to serious injury or death

TRUMA COMBI & WATER HEATER BY-PASS VALVE

IMPORTANT! Before winterizing your OP15 you must have a water heater by-pass kit installed. Running RV winterizing fluid through your Truma Combi water heater can cause corrosion and Truma advise against this in their manual therefore you must use the by-pass kit to winterize your camper.

If your OP15 was manufactured prior to 2022 and does not have a water heater by-pass kit installed, please contact OPUS HQ for information on ordering a kit and discuss with your local RV service department.

Please be advised that your Truma Combi system has a holding tank in it. Please ensure you carefully read the Truma Combi system manual for steps to drain the water heater tank of this appliance and prepare it properly for winterization. Always wait for the water heater tank to cool before draining. More information can also be found online at www.truma.net/about/news/winterizing-your-truma-aquago-or-truma-combi.

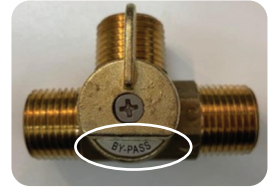
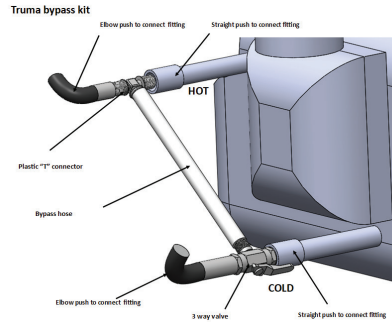

BY-PASS POSITION
FIGURE A



BY-PASS VALVE



DRAIN VALVE- CLOSED POSITION
FIGURE B

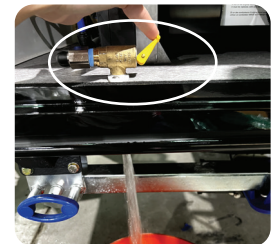

DRAIN VALVE- OPEN POSITION
FIGURE B2

TO WINTERIZE YOUR POTABLE WATER SYSTEM:

SET YOUR WATER HEATER TO BY-PASS MODE AT YOUR TRUMA COMBI:

1. Open the drain valve by moving the lever 90 degrees (Figure B) and drain water from Truma Combi (2.64 Gal/ 10 L for the complete drain) Note: make sure to keep a bucket underneath the drain valve
2. Turn the drain valve back to the closed position.
3. Turn the 3-way valve (Figure C) handle in a vertical direction (bypass position - Figure A)

EMPTY YOUR TANKS AND SYSTEM

Drain the water from your potable water system following the steps listed in the section above. (Figure B2) DO NOT use the water pumps to run your tanks dry.

AT YOUR WATER PUMP:

1. Remove the water filter
2. Remove the factory-installed cap from the 3-way valve
3. Turn the 3-way valve handle in a vertical direction (bypass position)
4. Attach the clear vinyl hose to the 3-way valve & hand tighten
5. Insert the end of the hose into the winterization fluid bottle
6. Using the water pump, run this winterizing fluid through the entire water system including the faucets and shower as well. This will lubricate and protect your water pump and fittings during storage. Close the outlet and turn the pump off.



PUMP & 3-WAY VALVE
FIGURE C



WATER FILTER

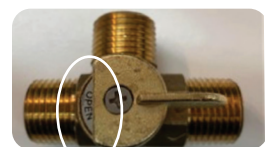

OPEN POSITION
FIGURE D

DE-WINTERIZING – RETURN TO THE ROAD

To de-winterize your potable water system follow these procedures:

1. Fill your water tanks with water and flush the water system with freshwater Note: Open all water release points (Shower, Sink, etc.). Make sure all the winterization fluid is flushed from the system.
2. Follow the steps above to sanitize your potable water system
3. Turn the 3-way valve handle of the water pump into a horizontal direction (Open Position - Figure D)

GREY WATER TANK

- Open your grey tank drain valve and drain into an appropriate receptacle. Dispose of grey water responsibly at a dump station or drain point.
- Always check the rules for the state and campground that you are visiting to see what limitations may apply.
- Do not dump illegally.
- We recommend flushing your grey tank after dumping to help remove any unwanted build up.
- For best maintenance of your grey water tank do not allow dirt, debris, hair or other solid material to drain into the grey tank.
- You may want to dump your gray tank after your black tank and use the grey water to help wash residue from the black tank sewer hose. See below section for winterizing your grey and black water tanks.

TO CLEAN YOUR GREY WATER TANK:

1. Fill your grey tank at least half way full with clean water. Add an RV grey water tank cleaning solution/ tablet and follow the instructions for that product or use dish soap or laundry detergent 1/2- 1 cup.
2. Do NOT use bleach as it will corrode your tank, seals and gaskets. Any damage caused by using bleach is not covered under warranty.
3. Take your OP15 for a spin to allow the grey water to slosh around and clean the inside of your tank and the tank sensors fully.
4. You can then drain the grey water tank as above and we suggest rinsing it using a wand-style rinser afterwards.
5. Following cleaning, use an RV grey water tank treatment to help dissolve grease and soap build up and prevent odors. We suggest using a natural, biodegradable enzyme based product that is formaldehyde-free such as Energen Grey Water Tank Treatment.

BLACK WATER TANK

We recommend emptying your black tank when it is at least 1/2 to 3/4 full and after every camping trip. Emptying your tank sooner may result in solid waste being left behind in your tank; a fuller tank allows more opportunity for breakdown of solid waste. If you are on-site camping and connecting to a campground sewer we recommend keeping the tanks drain valve closed until you need to drain to assisting in purging the tank of solid waste. Follow the OPUS tips for best results when using your OP15 toilet.

EMPTYING YOUR BLACK TANK

Please use caution when emptying to avoid contact with waste which can carry harmful bacteria. The black tank must ONLY be disposed of in designated dump stations. Do NOT dump illegally and follow all state and campground guidelines for safe and clean dumping. Use the black tank drain hose stowed at the rear of the trailer in the holding tube to drain your black tank.

1. Remove the black tank hose from the storage tube by twisting the cap off
2. Connect the drain hose to the drain valve by twisting on to receiver hooks
3. Ensure the other end of the drain hose is directed into the appropriate dump point.
4. To empty, pull the valve to open.
5. Leave the valve open until you can no longer hear liquid waste draining then close the valve completely. Close the valve at this point

WARNING: Do NOT leave waste in your tank during storage. Always remember to close the drain valve after draining the black tank and before removing the drain hose.

TO CLEAN YOUR BLACK WATER TANK:

1. Drain and dump any waste by following the steps above
2. Take measures to remove any build up from the tank walls. We recommend wand-style rinsers such as the Camco Swivel Stik that can be used with the toilet drain open to access the black tank.

3. Use a treatment product to clean your black tank. We recommend using a biodegradable, eco-friendly product that is enzyme-based. Please take care to ensure your treatment is formaldehyde-free—many dumping regulations now require this as standard. Follow the instructions on your chosen cleaning treatment to ensure the appropriate dilution as required. If you need to add water for your chosen product, you can do this by filling and flushing the toilet bowl several times.
4. If your sensors are not reading accurately and flushing the tank does not resolve the problem, tank sensor cleaning products are available to help remove buildup.
5. Your drain hose should also be regularly cleaned and sanitized.

WINTERIZING GREY & BLACK TANKS

1. Fully drain and clean the grey and black water tank following the above steps. Close your drain valves after draining.
2. Flush RV winterizing fluid down bathroom sink, shower drain & toilet (without flushing; ensure the drain valve is closed).
3. Winterizing fluid can remain in the tanks while in storage.

IMPORTANT! Monitor water temperatures closely in severe cold in case you must take the steps to drain and winterize your water systems whilst camping.

CHANGING A TIRE

- Ensure you are on level ground
- Deploy your corner steadies
- Use a jack on the suspension lift point to raise your trailer
- Change your wheel
- Torque all wheel bolts to 100ft lbs.
- When tightening wheel nut lugs, please tighten bolts in a star pattern order as indicated in the diagram to the right.

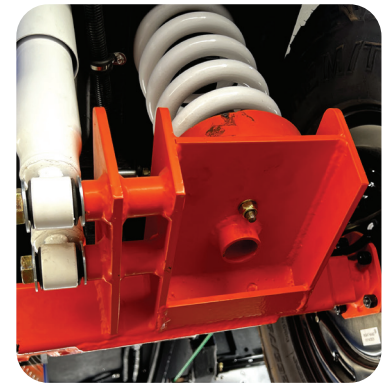
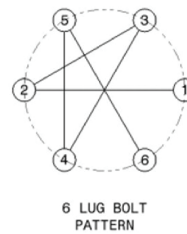

Important DO NOT use your corner steadies to lift the trailer off the ground

RETURNING TO THE ROAD

1. Ensure that your camper and accessories are fit for the road and you adhere to all local laws.
2. Check the wheels and tires and ensure they are in good condition with the bolts correctly torqued.
3. Check tire pressures once a month and before any extended trips
4. Check to ensure all bolts are tightened on the under carriage.
5. Check the lights and fittings and ensure they are functioning correctly.
6. Check the brakes are in good working order
7. The chassis/running gear and the gas installation of your OP15 camper should be checked on an annual basis by a qualified service center.
8. Purge your water tanks, sink and toilet of winterizing fluid
9. Change your water heater from by-pass mode to normal mode
10. Sanitize your potable water tank and add a treatment to the grey and black tanks as required.

CUSTOMER'S RESPONSIBILITIES

In order to ensure you get the most out of your OP15 and that warranty claims may be processed in a swift and timely manner, we ask that our customers adhere to the following guidelines:

1. Regular and proper maintenance of your OP15, including but not limited to the steps outlined in this user manual. If you have maintenance or service questions not covered by this manual OR you notice something out of the ordinary with your camper please contact your dealership for more information This includes scheduled maintenance of your OP15 and addressing any issues as they arise and without delay
2. It is the responsibility of the OP15 owner to ensure all warranty work is completed by an approved OPUS dealership. Failure to do so may result in incomplete or refusal of warranty claim repair cost reimbursement.
3. Any modifications without written consent from OPUS Camper could result in loss of warranty coverage. Contact us or your dealer before completing any work.

TOOLS & ACCESSORIES FOR YOUR OP15

ARK TONGUE JACK

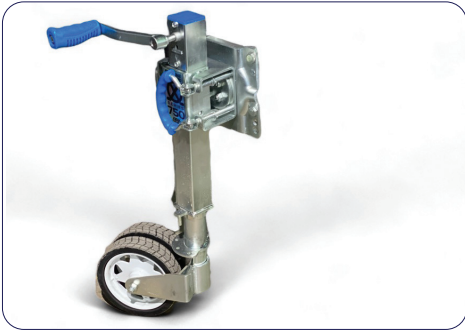

WHEEL CHOCKS



SPARE PROPANE REGULATOR



CRUISEMASTER DO35



MANUAL CRANK FOR STABILIZER

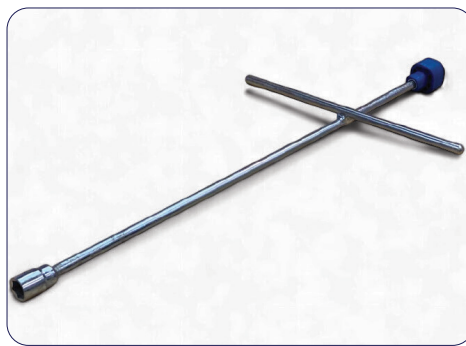

SHORE POWER EXTENSION



EXTRA KITCHEN SUPPORT LEG



DRILL BIT ADAPTER

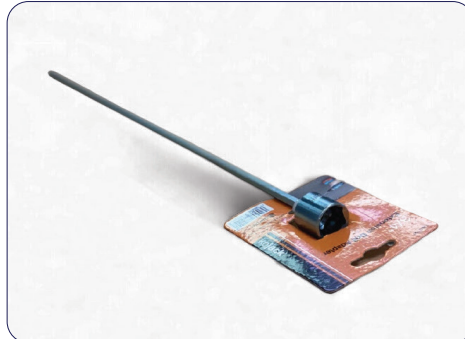

EXTERIOR LED LIGHT



EXTRA INTERIOR LIGHTS

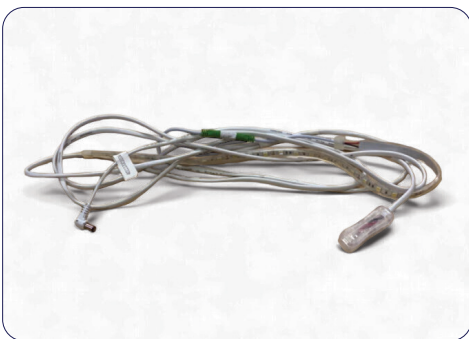

SHORE POWER PLUG



VEHICLE SIDE HITCH



OPUS LIMITED WARRANTY

Thank you for purchasing an OPUS® Product. This OPUS Limited Warranty (the “Warranty”) is the sole and exclusive warranty made or authorized by OPUS applicable to Camper Trailers and Trailer Mounted Tents (each a “Covered Product” and collectively “Covered Products”) so long as such items are used exclusively for recreational purposes in the United States or Canada for the 2025 model year purchased on or after September 2024.



Please refer to this [link](#) to view prior warranties. Please review this document carefully and should you have any question, please contact OPUS. By purchasing a Covered Product, you agree to all of the terms and conditions set forth in this Warranty.

Important Information Regarding Warranty Service and Repairs. Before making your purchase, please take note of the OPUS in-network service and warranty location nearest to you to ensure coverage is available locally. This OPUS Warranty covers warranty repair and service at the authorized dealership where you purchased your product. Warranty repair and service may be available at other authorized OPUS dealerships but please be aware that not all dealerships accept service appointments from customers who did not purchase their product from that dealer so please check prior to your purchase. This Warranty does not promise or extend to the future performance of a Covered Product and does not make any representations about how such Covered Products will perform in the future. This Warranty only covers the original purchaser’s remedy in the case where a Substantial Defect in materials or workmanship attributable to OPUS’ manufacture and assembly of the Covered Product exists, not Damages. “Damages” include issues or repairs stemming from misuse or collision that occurs after the purchase of the Covered Product by the first retail purchaser as well as due to a lack of maintenance (described below).



Warranty Period; Covered Items. The Warranty will be in effect for the following periods (the “Warranty Term”):

- For ninety (90) days from the original date of purchase, the Warranty will cover seals and sealants. Thereafter, the owner is solely responsible for such items are part of recommended maintenance.
- For twelve (12) months from the original date of purchase, the Warranty will cover all fittings, fixtures, canvas components, and poles.

- For sixty (60) months from the original date of purchase, the Warranty will cover the original purchaser from any defects in suspension components including the chassis, swing arms, and suspension springs.
- For sixty (60) months from the original date of purchase, the Warranty will cover the original purchaser from any defects in structural components including the sidewalls and skeletal framing.

Valid Claims and Exclusions

The Warranty is valid only from the date of original purchase of a Covered Product. It is non-transferable and is available only to the original purchasers. The Warranty only applies to Covered Products sold as “new” and does not extend to any items sold as “used” or “pre-owned”, sold via auction, as “factory seconds”, demonstration models or “damaged” which are sold “AS IS” unless otherwise stated in writing as part of the purchase contract. The Warranty is not transferrable under any circumstances and shall become null and void immediately upon the sale or other transfer by the original purchaser. The original purchaser may not make any Warranty claims on behalf of a transferee. This Warranty shall not apply to any products purchased as “new” from OPUS or an authorized OPUS dealer and then used for “hire schemes,” rentals, or for commercial or business purposes. The Warranty is limited to Covered Products purchased for recreational or personal use. All Warranty claims must be lodged by contacting your dealership.

The Warranty does not cover, and OPUS shall not be obligated to provide Warranty service or repair as a result of, any damage due to or as a result of any unauthorized modifications, misuse, abuse, collision, improper loading, incorrect assembly, incorrect or improper storage and packdown, improper or inadequate maintenance for recommended items (such as seals and sealants (after 90 days from original date of purchase)), lubricants, fluids and filters.

Additional Exclusions. The following items or not covered by this Warranty:

- Impact or stone damage to body, chassis, or running gear; soiling of fabrics and internal fitments or fittings from dust, dirt or other airborne substances; water damage from flood, water crossings or dangerous road conditions; fire; movement or damage caused by dislodgement of appliances and fittings resulting from hard impacts, heavy landings, or severely rutted roads or tracks; road damage, improper load balancing, vandalism, general damage arising from misuse; rust or corrosion; exposure to the elements; infestation by insects or animals; improper ventilation, interior or exterior condensation, mold, mildew or fungus; improper storage; damage caused by tow vehicle, improper selection or installation of a tow hitch or tow vehicle, weight distribution; wheels and tires; paint; travel covers and straps; general consumables (e.g. bearings, light bulbs; damage due to condensation; normal wear and tear (including use of a Covered Product as a permanent residence)); exposure to elements; windows, skylights and ceilings vents; camper fold-over cargo racks and spare tire carriers; side wall waterproofing and sealing, and water proofing and sealing of the fittings installed on the side wall; suspension gas shock absorbers. Covered Products are designed solely for recreational camping and personal use.

All Warranty service or repair must be done pursuant to any authorized claim approved by OPUS and must be performed by OPUS or an authorized dealer or representative, and only with OPUS' express written authorization. No affiliates, representatives, suppliers, resellers, or agents shall have any authority to authorize or deny a Warranty claim on behalf of OPUS. OPUS shall not be liable (in whole or in part) for any warranties, either express or implied, made by agents, resellers, or suppliers of OPUS without the knowledge or express written consent of OPUS. Such unauthorized warranties are the sole responsibility of the applicable agent, reseller or supplier.



Purchaser Obligations.

The Purchaser shall deliver the Covered Product for warranty service within a reasonable time after discovery of the defect and in no event after the expiration of the applicable Warranty Period described above. All expenses incurred by the Purchaser in obtaining Warranty service or repair shall be borne by the Purchaser. The Purchaser is advised to schedule an appointment with the selling dealer to avoid potential delays. If requested, you must provide written records showing that a Covered Product has been maintained as recommended in the owner's manual. Any repairs necessitated by an owner's failure to maintain the Covered Product as recommended are not covered by this Warranty.

Design Changes.

OPUS reserves the right to change the parts and design of its products, including Covered Products, from time to time without notice and with no obligation to maintain spare parts or make corresponding changes in its products previously manufactured and sold.

THIS WARRANTY GIVES THE OWNER SPECIFIC LEGAL RIGHTS, AND OTHER RIGHTS WHICH MAY VARY FROM STATE TO STATE.

LIMITATION AND DISCLAIMER OF WARRANTIES:

EXCEPT AS EXPRESSLY PROVIDED HEREIN, OPUS DISCLAIMS ALL OTHER WARRANTIES, EXPRESS OR IMPLIED, INCLUDING ANY IMPLIED WARRANTY OF MERCHANTABILITY OR FITNESS FOR A PARTICULAR PURPOSE. ANY WARRANTY THAT ARISES BY WAY OF FEDERAL OR STATE LAW, INCLUDING ANY IMPLIED WARRANTIES OF MERCHANTABILITY OR FITNESS FOR A PARTICULAR PURPOSE IS LIMITED TO, AND DOES NOT EXTEND BEYOND, THE SCOPE AND DURATION OF THE COVERAGE EXPRESSLY SET FORTH IN THIS LIMITED WARRANTY.

- **NOTE:** SOME STATES DO NOT PERMIT LIMITATIONS ON THE DURATION OF AN IMPLIED WARRANTY, SO THE LIMITATION REFERENCE ABOVE MAY NOT APPLY TO YOU.

Repair Remedy And Notice:

OPUS sole obligation under this Warranty is to repair any covered item discovered within the applicable Warranty Term if not excluded. If the authorized dealer or other authorized provider does not adequately repair the Covered Product, the owner must provide prompt written notice to OPUS at the address listed below and advise it of the defects and provide OPUS with an opportunity to make the repairs.

OPUS may require you to deliver the Covered Product to OPUS, another authorized dealer, or authorized service provider. OPUS may, in its sole discretion, cover the reasonable costs of transporting the Covered Product to its facilities. Refusal to allow OPUS an opportunity to repair the Covered Product will void the Warranty for the identified Substantial Defect. Owner must provide written notice and permit OPUS the opportunity to repair a Covered Product before Owner may initiate any action to seek legal or equitable remedies for breach of this Warranty or any implied warranties. Any claim for legal or equitable remedy must be initiated within one year after the date on which the breach occurs.

Goodwill Repairs:

Any repairs made by OPUS on portions of a Covered Product that are excluded from coverage or after the expiration of this Warranty shall be considered "Goodwill Repairs". OPUS is not obligated to provide Goodwill Repairs nor shall the provision hereof serve to alter or modify in any way the express terms of this Warranty. Email: info@opuscamper.com

Owner Assistance:

Your continued confidence and goodwill are important to OPUS as is maintaining a good relationship with our dealers. OPUS recognizes that there may be occasions when a warranty or service problem may not have been handled to your satisfaction. We encourage you to attempt to rectify any problems by discussing them with your local dealership's management. If, after doing so, your problem has not been resolved to your satisfaction, we welcome you to contact OPUS at the address listed below.

Contact Us:

If you have any questions relating to the Warranty, please contact us at: OPUS Camper USA.

701 Willow Pass Rd, Ste 8

Pittsburg, CA 94565

Email: info@opuscamper.com

DOMETIC PENGUIN II - 120v A/C

- The OP15 comes fitted with a rooftop Dometic Penguin II 120v A/C unit.
- Please read the instruction manual for this appliance in full before use.
- The full instruction manual is provided with your trailer, or you can find it online using the provided QR code.

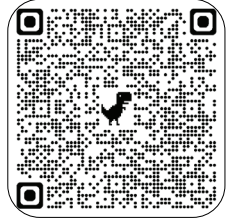

WINTERIZATION:

- To winterize your water heater, you will need to access the three way valve inside your trailer.
- It's located in the storage well with your inverter. You will see an enclosed white wall with a black lid labeled "Winterization"
- You will need to remove the three screws to access the winterization valve.



VICTRON INVERTER/CHARGER

- The OP15 comes fitted with a rooftop Dometic Penguin II 120v A/C unit. Please read the instruction manual for this appliance in full before use.
- The full instruction manual is provided with your trailer, or you can find it online using the provided QR code.



ICECO VL75 PRO 12V FRIDGE/FREEZER

- The OP15 comes with the Iceco VL60 Pro 12v Fridge/Freezer.
- We recommend reading the manufacturer's user manual that comes with your fridge in full to understand how this appliance works and to assist in troubleshooting should this be required.



FIAMMA F455 - RETRACTABLE AWNING

- The OP15 comes with a Fiamma retractable awning to provide coverage while cooking.
- When looking after your Fiamma awning, you should wash it with warm soapy water and let it dry completely before putting it away.
- The awning may only be used in very light wind and rain conditions.



DOWNLOAD VIRTUAL MANUAL

- Visit our Resources Page to find the most up-to-date manuals and user guides.
- You will also find helpful video resources for towing, hitching, maintenance and more.
- Find links to winterization and appliance manuals and installation guides.



OP15 USER MANUAL

A DETAILED GUIDE TO EVERYTHING YOU NEED TO KNOW ABOUT THE OP15

BUILT BY OPUS CAMPER USA IN PITTSBURG, CA

OP15



← OPUS